

HOLMAN

ASPECT *Wi-Fi Analyst* **WEATHER STATION**



12 WEATHER
DATA POINTS

Wi-Fi WEATHER STATION

PRODUCT CODE **WS5070W**

Contents

Introduction	3
Overview	4
Main Console	4
Analyst Outdoor Sensor	5
Installation and Setup	6
Analyst Outdoor Sensor	6
Main Console	7
Pairing	7
Changing Batteries and Manual Pairing	7
Wi-Fi Connection Setup	7
Wi-Fi Connection Status	9
Time Server Connection Status	9
Viewing Live Weather Data	10
Firmware Update (Desktop Only)	10
Operation and Settings	11
Clock	11
Moon Phase	11
Pointing the 5-in-1 Wireless Outdoor Sensor South	11
Setting Alarm Time	12
Comfort Indication	12
Activating Alarm and Temperature Pre-alarm	12
Temperature/Humidity Function and Trend	13
Wireless Sensor Signal Receiving	13
Wind	13
Weather Index	14
Weather Forecast	14
Barometric Pressure	15
Rainfall	15
MAX/MIN Data Record	15
Past 24 Hours History Data	16
Maintenance	17
Battery Replacement	17
Cleaning the Rain Collector	17
Cleaning Outdoor Hygro-Thermo Sensor	17
Precautions	18
Warranty	19
Specifications	20

Introduction

Thanks for choosing our **Aspect Wi-Fi Analyst**. This system gathers and automatically uploads accurate and detailed weather data to [Weather Underground](#), where you can access and upload your weather data.

This product offers professional weather observers or serious weather enthusiasts robust performance with a wide range of options and sensors.

The **Aspect Wi-Fi Analyst** transmits indoor/outdoor temperature, humidity, wind and rain data. Both sensors are fully assembled and calibrated for your easy installation. They send data at a low power radio frequency to the **Main Console** from up to 150m/450 feet away (line of sight).

A high-speed processor is embedded in the **Main Console** which analyses real-time data. This can be published to [Weather Underground](#) through your home Wi-Fi router.

The **Main Console** can also synchronise with an internet time server to keep the time and weather data time stamp at high precision. The colour background LCD display shows informative weather readings with advanced features, such as high/low alert alarm, different weather index, and MAX/MIN records. With calibration and moon phase features, this system is truly a remarkably personal yet professional weather station for your own backyard.

- i** This instruction manual contains useful information on the proper use and care of this product. Please read this manual thoroughly to fully understand and enjoy its features, and keep it handy for future use.

Overview

Main Console

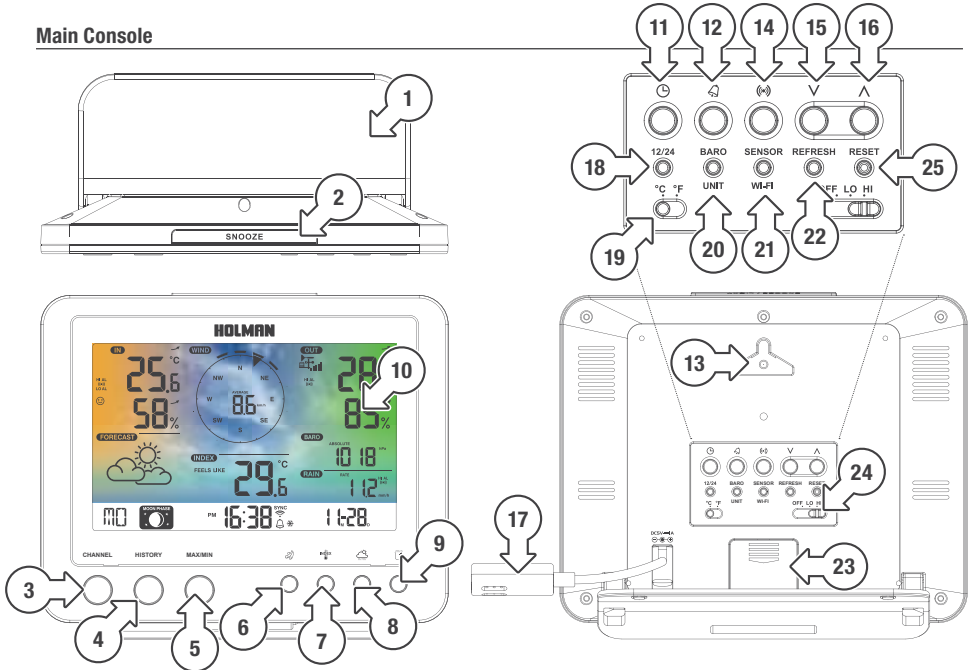

- | | | |
|----------------------|---|--|
| 1. Table stand | 15. \checkmark | 26. Indoor/CH temperature and humidity |
| 2. SNOOZE | 16. \wedge | 27. Weather forecast |
| 3. CHANNEL | 17. Power jack | 28. Time, calendar the moon phase |
| 4. HISTORY | 18. 12/24 | 29. Wind direction then speed |
| 5. MAX/MIN | 19. $^{\circ}\text{C}/^{\circ}\text{F}$ | 30. Outdoor temperature then humidity |
| 6. WIND | 20. BARO UNIT | 31. Barometer |
| 7. INDEX | 21. SENSOR/Wi-Fi | 32. Rainfall |
| 8. BARO | 22. REFRESH | 33. Weather index |
| 9. RAIN | 23. Battery compartment | |
| 10. LCD display | 24. OFF/LO/HI slider | |
| 11. CLOCK SET | 25. RESET | |
| 12. ALARM | | |
| 13. Wall mount | | |
| 14. ALERT | | |

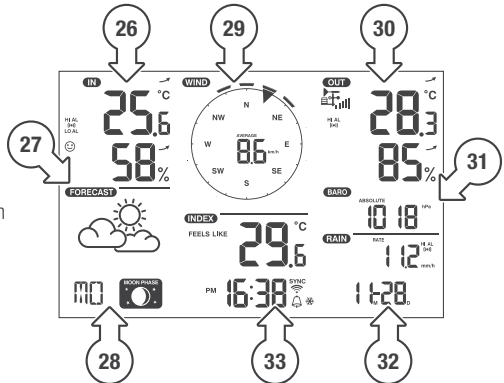

Overview (continued)

Analyst Outdoor Sensor



1. Rain collector
2. Balance indicator
3. Antenna
4. Wind cups (anemometer)
5. Mounting pole
6. Louvre shield for temperature and humidity sensor
7. Wind vane
8. Mounting base
9. Mounting clamp
10. Red LED indicator
11. **RESET**
12. Battery door
13. Screws
14. Tipping bucket
15. Rain sensor
16. Drain holes

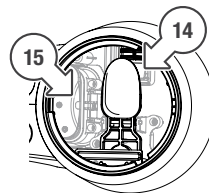

Installation and Setup

Analyst Outdoor Sensor

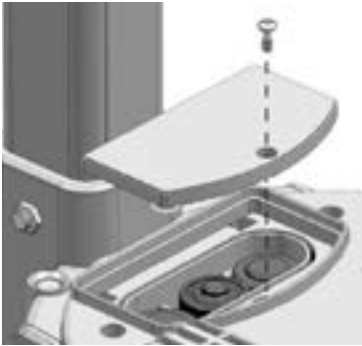

Install Batteries:

1. Unscrew the battery door at bottom of unit and insert the batteries according to the +/- polarity indicated
 - ⓘ Ensure battery terminals are clean when installing batteries
 - ⓘ Outside batteries are positive down, the centre battery is positive up as shown above
 - ⓘ Use regular alkaline or lithium batteries, never rechargeable
2. Screw the battery door compartment on tightly
 - ⓘ Ensure the water tight o-ring is properly aligned in place to ensure water resistance.
 - ⓘ The red LED will begin flashing every 12 seconds.

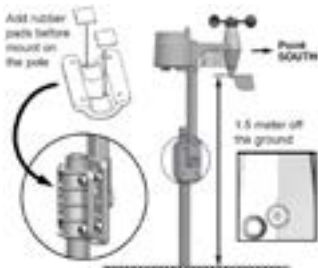

Assembly of Stand and Pole:

1. Insert the top side of the pole to the square hole of the weather sensor
 - ⓘ Ensure the pole and sensor's indicator align
2. Place the nut in the hexagon hole on the sensor, then insert the screw in other side and tighten it with a screw driver
3. Insert the other side of the pole to the square hole of the plastic stand
 - ⓘ Ensure the pole and stand indicator align
4. Place the nut in the hexagon hole of the stand, then insert the screw in other side and then tighten it with a screw driver

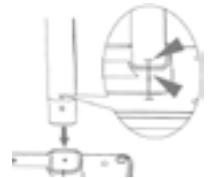
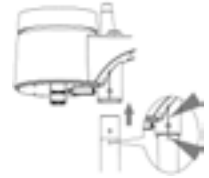

Positioning: Install the **Outdoor Sensor** in an open location with no obstructions above and around the sensor for accurate rain and wind measurement. Install the sensor with the smaller end facing the South to properly orient the wind direction vane. Secure the mounting stand and bracket (included) to a post or pole, and allow minimum 1.5m off the ground.

Installation and Setup (continued)

Main Console

Install Backup Battery:



1. Detach the table stand as shown

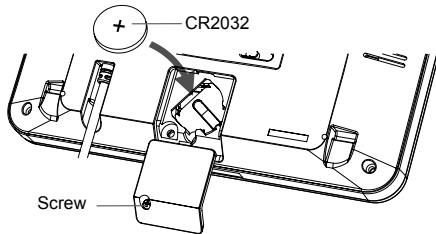

2. Unscrew the console battery door screw
3. Remove the battery door
4. Insert a new button cell battery
5. Replace the battery door and tighten the screw

i The backup battery can backup time, date, max/min, past 24 hour weather records, alert setting values, offset value of weather data and sensor channel history.

i The built-in memory can backup router settings and weather server settings

Main Console Power-up:

1. Plug the power adaptor to power up the **Main Console**.
 2. Once the **Main Console** has powered, up, all the segments of the LCD will be shown.
 3. The **Main Console** will automatically start **AP Mode**
- ☑ If no display appears on the LCD after you plug the adaptor, press **RESET** using a pointed object.

Setting LCD Viewing Angle: Press **^** or **v** in **Normal Mode** to adjust LCD viewing angle to fit table stand or wall mount situation.



WARNING!

**KEEP NEW OR USED
BUTTON/COIN
BATTERIES OUT OF
REACH OF CHILDREN**



The battery can cause severe or fatal injuries in 2 hours or less if it is swallowed or placed inside any part of the body. If you think batteries may have been swallowed or placed inside any part of the body, seek immediate medical attention

Contact the **Australian Poisons Information Centre** for 24/7 fast, expert advice: ☎ **13 11 26**

Refer to your local government guidelines on how to correctly dispose of button/coin batteries.

Installation and Setup (continued)

Pairing

After inserting batteries, the **Main Console** will automatically search and connect the wireless **Outdoor Sensor** (the sensor antenna icon blinking).

Once the connection is successful, the antenna icon and readings for outdoor temperature and humidity, wind speed, wind direction and rainfall will appear on the LCD.

The **Main Console** can pair with 1× **Outdoor Sensor** and up to 7× **Hygro-Thermo Indoor Sensors** (not included)

Changing Batteries and Manual Pairing

Whenever batteries are changed in the **Outdoor Sensor**, pairing must be done manually.

1. Replace *all* the batteries in the sensor.
2. Press **SENSOR/Wi-Fi** on the **Main Console**.
3. Press **RESET** on the **Outdoor Sensor**

Wi-Fi Connection Setup

i To connect this **Aspect Wi-Fi Analyst** to Wi-Fi, it must be registered with [Weather Underground](#).



i [Weather Underground](#) setup instructions are correct as of January 2019. Refer to <https://www.wunderground.com/> for details if their registration process has changed.

Register your Aspect Wi-Fi Analyst with [Weather Underground](#):

1. Visit <https://www.wunderground.com/> and click **JOIN** in the top right corner and follow the prompts to create an account. Note that your email address must be validated by [Weather Underground](#) before proceeding. If you already have an account, you can simply **LOG IN**
2. After logging in to your account, click **MY PROFILE** and select **MY DEVICES** in the menu. On the following page, click **ADD A NEW PWS**

Installation and Setup (continued)

Wi-Fi Connection Setup (continued)

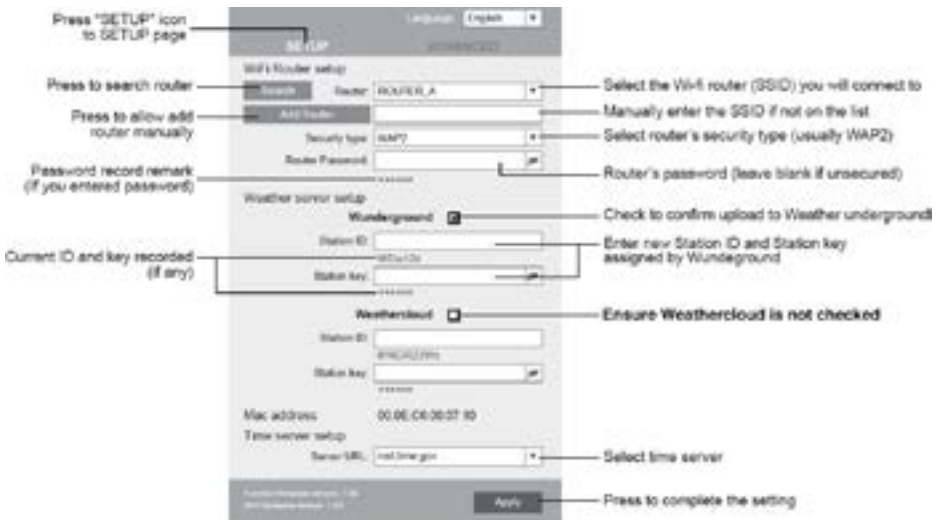

- After submitting your details, note **it is essential** to jot down your **STATION ID** and **STATION KEY/PASSWORD**.
 - When you first power up the **Main Console**, or hold **SENSOR/Wi-Fi** for 6 seconds in **Normal Mode**, the LCD will show **AP** and the Wi-Fi icon  to signify it has entered **AP (Access Point) Mode**, and is ready for Wi-Fi settings
- 
- Using your device, connect to the **Main Console** via Wi-Fi. In the device Wi-Fi connection settings, select the **Main Console** SSID (PWS-#####) and wait several seconds for connection
 - This may temporarily disconnect your computer or smartphone from the internet, and will reconnect at the end of the setup process
 - Once connected, open the web browser on your device, type 192.168.1.1 into the address bar and press **ENTER** to access the **Main Console** setup interface
 - Enter the following information into the **Main Console** setup interface. If you choose not to use [Weather Underground](#), leave the check boxes unchecked



- When Wi-Fi setup is complete, you can reconnect your device to your home Wi-Fi network if it hasn't already
- During **AP Mode**, you can press and hold **SENSOR/Wi-Fi** for 6 seconds to stop **AP Mode** and the **Main Console** will restore your previous setting
- Use the **ADVANCED** tab to set the **RELATIVE PRESSURE OFFSET**. Do this by checking your **Weather Station** outdoor pressure reading against the [Bureau of Meteorology](#) reading for your area

Installation and Setup (continued)

Wi-Fi Connection Status

		
Stable: Console is in connection with WI-FI router	Flashing: Console is trying to connect to WI-FI router	Flashing: Console currently in Access Point (AP) mode

Time Server Connection Status

After the **Main Console** has connected to the internet, it will attempt to connect to the internet time server to obtain the UTC time. Once the connection succeeds and the **Main Console** time has been updated, the **SYNC** icon will appear on the LCD.



Time Zone: To display the time of your time zone, change the time zone in **Clock Setting Mode** from '00' (default) to your time zone (e.g. 08 for Perth).

- Press and hold **CLOCK SET** for 2 seconds to enter **Clock Setting Mode**.
 - Press **^** or **v** to enter your time zone, then press and hold **CLOCK SET** to confirm and exit.
- i** The time will automatically synchronise with internet time server at 12:00AM and 12:00PM per day. Also you can press **REFRESH** to get the internet time manually within 1 minute.

Calibration

Press **ADVANCED** at the top of web interface to enter the advance setting page, this page allow you to set and view the calibration data. Firmware can also be updated here.

- User may enter or change the offset and gain values for different measurement parameters while current offset and gain values are shown next to their corresponding boxes
 - Once completed, press **APPLY** in the **Setup** page. To change offset values, input the new value and press **APPLY**
- i** Calibration of most parameters is not required, with the exception of **Relative Pressure**, which must be calibrated to sea-level to account for altitude effects.

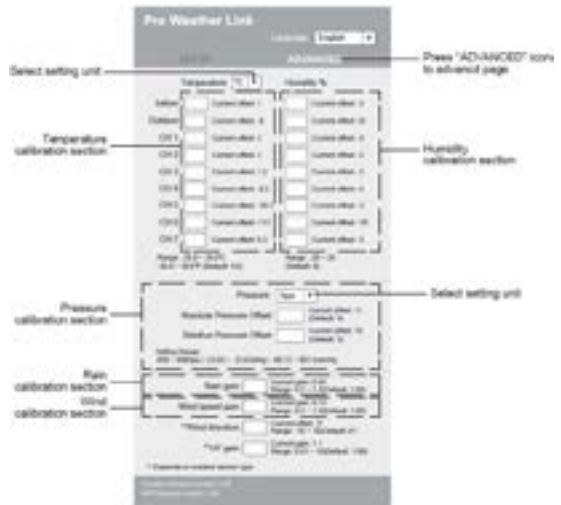

Installation and Setup (continued)

Viewing Live Weather Data

To view live data from the wireless outdoor sensor in a web browser, visit <https://www.wunderground.com/>, and enter your **STATION ID** in the search box. Weather information will show on the next page.

Firmware Update (Optional–Desktop Only)

The **Main Console** supports OTA firmware update capability. *This is optional and not necessary for setup out of the box.* Firmware may be updated through any desktop web browser with Wi-Fi connectivity. Update function is not available through mobile devices. Two types of firmware updates are available, namely **Function Firmware** and **Wi-Fi Firmware**, and are located at the bottom of the **ADVANCED** tab during [Wi-Fi Connection Setup](#) for the **Main Console**.

1. Download the latest version firmware to your desktop computer.
2. Set the **Main Console** into **AP Mode** then connect your desktop to the **Main Console** (refer to [Wi-Fi Connection Setup](#) for more details).
3. To update **Function Firmware**, click **BROWSE** in **Function Firmware** section and browse to the location of the file you downloaded in *Step 1* above. To update the **Wi-Fi Firmware**, click **BROWSE** in **Wi-Fi Firmware** section.



4. Click the corresponding **UPLOAD** to start transferring the firmware file to the **Main Console** (indicated by a transfer completion %).

5. After the transfer, update process is indicated on the **Main Console** as completion %. It will restart once the update is complete.



- i** **Function Firmware** and **Wi-Fi Firmware** cannot be updated at the same time, you need to update each one by one.
- i** Keep power connected during the firmware update process.
- i** Ensure your desktop Wi-Fi connection is stable during update process.
- i** Once update process has started, do not operate desktop or **Main Console**.
- i** During firmware update, the **Main Console** will stop uploading data. It will reconnect to your Wi-Fi router and upload the data again once the update has succeeded. If the **Main Console** cannot reconnect to your Wi-Fi router, please close the **Setup** page to start again.
- i** After firmware updates, user might need to input the [Weather Underground](#) ID and password again.

Operation and Settings

Clock

This **Main Console** is designed to obtain the local time by synchronising with the assigned internet time server. If you want to use it offline, you can set the time and date manually. During initial start-up, press and hold **SENSOR/Wi-Fi** for 6 seconds and set the **Main Console** back to **Normal Mode**.

















1. In **Normal Mode**, press and hold **CLOCK SET** for 2 seconds.
2. The setting sequence is as follows:
TIME ZONE > HOUR > MINUTE > 12/24 HOUR FORMAT > YEAR > MONTH > DAY > M-D/D-M FORMAT > TIME SYNC ON/OFF > WEEKDAY LANGUAGE
3. Press **▲** or **▼** to change the value. Press and hold **▲** or **▼** for quick-adjust.
4. Press **CLOCK SET** to save and exit **Clock Set Mode**, or the unit will automatically exit 60 seconds later without pressing any key.

i In **Normal Mode**, press **CLOCK SET** key to switch between year and date display.

i During the setting, you can press and hold **CLOCK SET** for 2 seconds to return to **Normal Mode**.

Moon Phase

The moon phase is determined by the time, date and time zone. The following table explains the moon phase icons of the Northern and Southern hemispheres. Refer to **Pointing the 5-in-1 Wireless Outdoor Sensor Towards South** section about how to setup for the Southern hemispheres.

Northern hemisphere	Moon Phase	Southern hemisphere
	New Moon	
	Waxing Crescent	
	First quarter	
	Waxing Gibbous	
	Full Moon	
	Waxing Gibbous	
	Third quarter	
	Waxing Crescent	

Pointing the 5-in-1 Wireless Outdoor Sensor South

The **5-in-1 Wireless Outdoor Sensor** is calibrated to point to North for the maximum accuracy. However, for the user's convenience (e.g. users in the Southern hemisphere), it is possible to use the sensor with the wind vane pointing to South.

1. Install the **5-in-1 Wireless Outdoor Sensor** with its wind meter end pointing to South.
 2. In **Normal Mode** of the **Main Console**, press and hold **INDEX** for 10 seconds to enter into **Orientation Mode**, then press **INDEX** again until the **N** icon appears on the left bottom corner of the LCD to enter into the sensor orientation.
 3. Press **▲** or **▼** to change to Southern Hemisphere.
 4. Press **INDEX** to confirm and exit.
- i** Changing the hemisphere setting will automatically switch the direction of the moon phase on the display.

Operation and Settings (continued)

Setting Alarm Time

1. In **Normal Time Mode**, press and hold **ALARM** for 2 seconds until the alarm hour digit flashes to enter **Alarm Time Setting Mode**.
 2. Press **▲** or **▼** key to change the value. Press and hold **▲** or **▼** for quick-adjust.
 3. Press **ALARM** again to switch the setting value to **Minute** with the minute digit flashing.
 4. Press **▲** or **▼** key to adjust the value of the flashing digit.
 5. Press **ALARM** key to save and exit the setting.
- i** In **Alarm Mode**, the  icon will display on the LCD.
 - i** The alarm function will turn on automatically once you set the alarm time.

Comfort Indication

The comfort indication is a pictorial indication based on indoor air temperature and humidity in an attempt to determine comfort level.

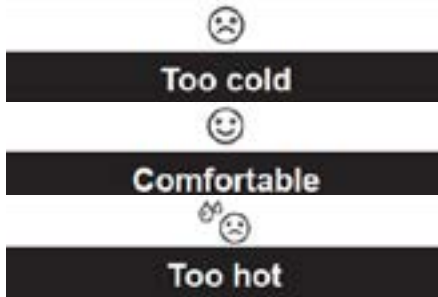

- i** There is no comfort indication when temperature is below 0°C (32°F) or over 60°C (140°F).

Activating Alarm and Temperature Pre-alarm

1. In **Normal Mode**, press **ALARM** to show the alarm time for 5 seconds.
2. When the alarm time displays, press **ALARM** again to activate the alarm function, *or* press **ALARM** key twice to activate the alarm with ice pre-alarm function.



- i** Once the ice pre-alert activates, the pre-set alarm will sound and ice-alert icon will flash 30 minutes earlier if the outdoor temperature is below -3°C.
- i** Alarm will stop automatically after 2 minutes and the alarm will activate again in the next day.
- i** Pressing **SNOOZE** will snooze the alarm for 5 minutes.
- i** Pressing and holding **SNOOZE** for 2 seconds will stop the alarm.
- i** By pressing **ALARM** will stop the alarm.
- i** During the snooze, the alarm icon  will keep flashing.

Operation and Settings (continued)

Temperature/Humidity Function and Trend

Use the °C/°F slide switch to select the temperature display unit.

Arrow indicator			
Temperature / Humidity trend	Rising	Steady	Falling

- ❶ When indoor temperature is below -40°C, the LCD will display **LO**. If temperature is above 70°C, LCD will display **HI**.
- ❷ When outdoor temperature is below -40°C, the LCD will display **LO**. If temperature is above 80°C, LCD will display **HI**.
- ❸ When humidity is below 1%, LCD will display **LO**. If humidity is above 99%, LCD will display **HI**.

Wireless Sensor Signal Receiving

1. The **Main Console** display signal strength for the **5-in-1 Wireless Outdoor Sensor**, is as per the table below:

		
No signal	Weak signal	Good signal

- 2. If the signal has discontinued and does not recover within 15 minutes, the signal icon will disappear. The temperature and humidity will display **ER** for the corresponding channel.
- 3. If the signal does not recover within 48 hours, the **ER** display will become permanent. You need to replace the batteries and then press **SENSOR/Wi-Fi** to pair the sensor again.

Wind

Set Wind Speed Unit and Direction Display Format:

- 1. In **Normal Mode**, press and hold **WIND** key for 2 seconds to enter into **Wind Speed Unit Mode** and the unit will flash. Press **^** or **v** to change the wind speed unit in this sequence:
m/s > km/h > KNOTS > mph
- 2. Press **WIND** key again to return to **Normal Mode**.

Select Wind Display Mode: In **Normal Mode**, press **WIND** to switch between **Average** and **Gust** wind speed.

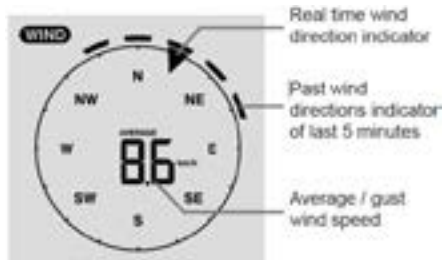

Operation and Settings (continued)

Weather Index

Press **INDEX** to view the weather index in this sequence: **FEELS LIKE > HEAT INDEX > WIND CHILL > DEW POINT**

Feels Like: Estimates the outdoor temperature that people actually feel.

Heat Index: Determined by the **5-in-1 Wireless Outdoor Sensor** temperature and humidity data, when the temperature is between 27°C and 50°C.







Heat Index range	Warning	Explanation
27°C to 32°C (80°F to 90°F)	Caution	Possibility of heat exhaustion
33°C to 40°C (91°F to 105°F)	Extreme Caution	Possibility of heat dehydration
41°C to 54°C (106°F to 129°F)	Danger	Heat exhaustion likely
≥55°C (≥130°F)	Extreme Danger	Strong risk of dehydration / sun stroke

Wind Chill: A combination of temperature and wind speed data from the **5-in-1 Wireless Outdoor Sensor**, which determines the current wind chill factor.

Dew Point: The dew point is the temperature below which the water vapour in air at constant barometric pressure condenses into liquid water at the same rate at which it evaporates. The condensed water is called dew when it forms on a solid surface. The dew point temperature is determined by the temperature and humidity data from the **5-in-1 Wireless Outdoor Sensor**.

Weather Forecast

The built-in barometer can notice atmosphere pressure changes. Based on the data collected, it can predict the weather conditions in the forthcoming 12~24 hours within a 30~50km radius.

					
Sunny	Partly cloudy	Cloudy	Rainy	Rainy / Stormy	Snowy

- i** The accuracy of a general pressure-based weather forecast is about 70% to 75%.
- i** The weather forecast is reflecting the weather situation for next 12~24 hours, it may not necessarily reflect the current situation.
- i** The **SNOWY** weather forecast is not based on the atmospheric pressure, but based on the outdoor temperature. When the temperature is below -3°C (26°F), the SNOWY weather icon will be displayed on the LCD.

Barometric Pressure

Setting the Barometer Unit: In **Normal Mode**, press **BARO UNIT** to change the barometer unit in this sequence: **hPa > inHg > mmHg**

Operation and Settings (continued)

Rainfall

Setting Rainfall Units:

1. Press and hold **RAIN** key for 2 seconds to enter **Unit Setting Mode**.
2. Press **▲** or **▼** to toggle the rainfall unit between mm and in.
3. Press **RAIN** key to confirm and exit the setting

Selecting Rainfall Display Mode:

Press **RAIN** to toggle between:

- HOURLY:** Total rainfall in the past hour
- DAILY:** Total rainfall from midnight
- WEEKLY:** Total rainfall of the current week
- MONTHLY:** Total rainfall of the current calendar month
- TOTAL:** Total rainfall since the last reset
- RATE:** Current rainfall rate in past hour

Resetting the Total Rainfall Record: In **Normal Mode**, press and hold **HISTORY** for 2 seconds to reset all the rainfall record.

- i** To ensure correct data, reset Total Rainfall Record when moving the **5-in-1 Wireless Outdoor Sensor** to a new location.

MAX/MIN Data Record

The **Main Console** can record the accumulated MAX/MIN data with a time stamp for easy reviewing.

In **Normal Mode**, press **MAX/MIN** key to check records:

INDOOR (OR CURRENT CHANNEL) MAX TEMPERATURE > INDOOR (OR CURRENT CHANNEL) MIN TEMPERATURE > INDOOR (OR CURRENT CHANNEL) MAX HUMIDITY > INDOOR (OR CURRENT CHANNEL) MIN HUMIDITY > OUTDOOR MAX TEMPERATURE > OUTDOOR MIN TEMPERATURE > OUTDOOR MAX HUMIDITY > OUTDOOR MIN HUMIDITY > MAX AVERAGE WIND SPEED > MAX GUST > MAX RELATIVE PRESSURE

> MIN RELATIVE PRESSURE > MAX ABSOLUTE PRESSURE > MIN ABSOLUTE PRESSURE > MAX FEELS LIKE > MIN FEELS LIKE > MAX HEAT INDEX > MIN HEAT INDEX > MAX WIND CHILL > MIN WIND CHILL > MAX DEW POINT > MIN DEW POINT > MAX DAILY RAINFALL

Clearing MAX/MIN Records: Press and hold **MAX/MIN** key for 2 seconds to reset records of specific weather display section.

- i** The LCD will also display the **HISTORY** icon, data records, time and date.

Past 24 Hours History Data

1. Press **HISTORY** key to check the beginning of the current hour's weather data
e.g. the current time is 7:25 am, March 8, the display will show the data of 7:00am, March 8
2. Press **HISTORY** key repeatedly to view older readings of the past 24 hours
e.g. 6:00am (Mar 8), 5:00am (Mar 8), ..., 10:00am (Mar 7), 9:00am (Mar 7), 8:00am (Mar 7)

The LCD will also display the **HISTORY** icon, history data records with time and date.

Operation and Settings (continued)

Weather Alert Setting

Weather Alert can alert you of certain weather conditions. Once the alert criteria is met, the alarm sound will activate and the LCD alert icon will flash.

To Set Alert:

1. Press **ALERT** to select and display the desired weather alert reading in the sequence below:

Alert reading Sequence	Setting Range	Display Section	Default Value
Indoor Temperature High Alert (current channel)	-40°C ~ 80°C	Indoor / CH temperature & humidity	40°C
Indoor Temperature Low Alert (current channel)			0°C
Indoor Humidity High Alert (current channel)	1% ~ 99%		80%
Indoor Humidity Low Alert (current channel)			40%
Outdoor Temperature High Alert	-40°C ~ 80°C	Outdoor temperature & humidity	40°C
Outdoor Temperature Low Alert			0°C
Outdoor Humidity High Alert	1% ~ 99%		80%
Outdoor Humidity Low Alert			40%
Average Wind Speed	0.1m/s ~ 50m/s	Wind direction & speed	17.2mm/h
Pressure Drop	1hPa ~ 10hPa	Barometer	3hPa
Hourly Rainfall	1mm ~ 1000mm	Rainfall	100mm

2. Under the current alert reading, press and hold **ALERT** key for 2 seconds to enter alert setting and the alert reading will flash.
3. Press **▲** or **▼** key to adjust the value or press and hold the key to change rapidly.
4. Press **ALERT** key to confirm the value. Press **ALARM** key to toggle the regarding alert on/off.
5. Press **ALERT** key to step to next alert reading.
6. Press any key on the front side to save alert on / off status and go back to **Normal Mode**.



Silencing the Alert Alarm: Press **SNOOZE** key to silence the alert alarm or let the alarm automatically turn off after 2 minutes.

- ❗ Once the alert is triggered, the alarm will sound for 2 minutes and the related alert icon and readings will flash.
- ❗ The weather alert will sound again when the weather readings falls into the alert range again.

Maintenance

Battery Replacement

If the low battery indicator  is displayed in **OUT** or **CH** section, it indicates that the current channel wireless or outdoor 5 in 1 sensor battery power is low. You should replace all the batteries in the current channel sensor at once.



Cleaning the Rain Collector



1. Unscrew the rain collector by turning it 30° anti-clockwise.
2. Gently remove the rain collector.
3. Clean and remove any debris or insects.
4. Install the collector when it is clean and fully dried.

Cleaning Outdoor Hygro-Thermo Sensor

1. Remove the 2 screws at the bottom of the louvre shield.
2. Gently pull out the shield.
3. Carefully remove any dirt or insects on the sensor casing (do not let the sensors inside get wet).
4. Clean the shield with water to remove any dirt or insects.
5. Reinstall all the parts when they are clean and fully dried.



Maintenance (continued)

Precautions

- i** Keeping and reading this manual is highly recommended. The manufacturer and supplier cannot accept any responsibility for any incorrect readings, export data lost and any consequences that occur should an inaccurate reading take place
- i** This product is designed for use in the home only as an indication of weather conditions. This product is not to be used for medical purposes or for public information
- i** Do not subject the unit to excessive force, shock, or dust
- i** Do not cover the ventilation holes with any items such as newspapers, curtains etc.
- i** Do not immerse the unit in water. If you spill liquid over it, dry it immediately with a soft, lint free cloth
- i** Do not clean the unit with abrasive or corrosive materials
- i** Do not tamper with the unit's internal components. This invalidates the warranty.
- i** Placement of this product on certain types of wood may result in damage to its finishing for which manufacturer will not be responsible. Consult the furniture manufacturer's care instructions for information
- i** Only use fresh batteries. Do not mix new and old batteries
- i** Only use attachments/accessories specified by the manufacturer
- i** Images shown in this manual may differ from the actual display
- i** Dispose of used batteries according to the instructions
- i** The contents of this manual may not be reproduced without the permission of the manufacturer
- i** Technical specifications and user manual contents for this product are subject to change without notice
- i** When replacement parts are required, be sure the service technician uses replacement parts specified by the manufacturer that have the same characteristics as the original parts.
- i** Unauthorised substitutions may result in fire, electric shock, or other hazards.
- i** This product is not a toy. Keep out of reach of children
- i** The **Main Console** is intended for indoor use only.
- i** Place the **Main Console** at least 20cm from nearby persons

Warranty

2 Year Replacement Guarantee

Holman offers a 2 year replacement guarantee with this product.

In Australia our goods come with guarantees that cannot be excluded under the Australian Consumer Law. You are entitled to a replacement or refund for a major failure and compensation for any other reasonably foreseeable loss or damage. You are also entitled to have the goods repaired or replaced if the goods fail to be of acceptable quality and the failure does not amount to a major failure.

As well as your statutory rights referred to above and any other rights and remedies you have under any other laws relating to your Holman product, we also provide you with a Holman guarantee.

Holman guarantees this product against defects caused by faulty workmanship and materials for 2 years domestic use from the date of purchase. During this guarantee period Holman will replace any defective product. Packaging and instructions may not be replaced unless faulty.

In the event of a product being replaced during the guarantee period, the guarantee on the replacement product will expire 2 years from the purchase date of the original product, not 2 years from the date of replacement.

To the extent permitted by law, this Holman Replacement Guarantee excludes liability for consequential loss or any other loss or damage caused to property of persons arising from any cause whatsoever. It also excludes defects caused by the product not being used in accordance with instructions, accidental damage, misuse, or being tampered with by unauthorised persons, excludes normal wear and tear and does not cover the cost of claiming under the warranty or transporting the goods to and from the place of purchase.

Should you suspect your product may be defective and need some clarification or advice please contact us directly:

1300 716 188

support@holmanindustries.com.au

11 Walters Drive, Osborne Park 6017 WA

If you are certain your product is defective and is covered by the terms of this warranty, you will need to present your defective product and your purchase receipt as proof of purchase to the place you purchased it from, where the retailer will replace the product for you on our behalf.

Specifications

Main Console

The following details are listed as they are displayed or operate on the **Main Console**

General	
Dimensions (W × H × D)	136 × 168 × 24.5mm (5.4 × 6.6 × 1in)
Weight	370g (with batteries)
Main Power	DC 5V, 1A adaptor
Backup Battery	CR2032, 3V batteries
Operating Temperature range	-5°C ~ 50°C
Wi-Fi Communication	
Wi-Fi Standard	802.11 b/g/n
Wi-Fi Operating Frequency	2.4GHz
Supported Router Security Type	WPA/WPA2, OPEN, WEP (WEP only support Hexadecimal password)
Supported Device for Setup UI	Built-in Wi-Fi with AP Mode function smart devices, laptops or desktops: Android smart phone, Android pad, iPhone, iPad or Windows laptop
Recommended Web Browser for Setup UI	Web browsers that support HTML 5, such as the latest version of Chrome, Safari, Edge, Firefox or Opera.
Wireless Sensor	
Support Sensors	1× Analyst Outdoor Sensor and up to 7× Wireless Hygro-Thermo indoor sensors
RF Frequency	917Mhz (AU version)
RF Transmission Range	150m
Time	
Time display	HH: MM
Hour format	12hr AM/PM or 24 hr
Date display	DD/MM or MM/DD
Time synchronise method	Through Internet time server to synchronise the UTC
Weekday languages	EN/DE/FR/ES/IT/NL/RU
Time Zone	13 ~ -12 hour
DST	ON/OFF

Barometer	
Barometer unit	hPa, inHg and mmHg
Measuring range	540 ~ 1100hPa (relative setting range 930 ~ 1050hPa)
Accuracy	(700 ~ 1100hPa ± 5hPa)/(540 ~ 696hPa ± 8hPa)/(20.67 ~ 32.48inHg ± 0.15inHg)/(15.95 ~ 20.55inHg ± 0.24inHg)/(525 ~ 825mmHg ± 3.8mmHg)/(405 ~ 522mmHg ± 6mmHg) Typical at 25°C (77°F)
Resolution	1hPa/0.01inHg/0.1mmHg
Weather forecast	Sunny/Clear, Slightly Cloudy, Cloudy, Rainy, Rainy/Stompy and Snowy
Display modes	Current
Memory modes	Historical data of past 24 hours, daily Max/Min
Alarm	Pressure change alert
Indoor/Outdoor Temperature	
Temperature unit	°C and °F
Display range	Indoor: -40 ~ 70°C (-40 ~ 158°F), Outdoor: -40 ~ 80°C (-40 ~ 176°F)
Indoor Accuracy	<0°C or >40°C ± 2°C (<32°F or >104°F ± 3.6°F) 0~40°C ± 1°C (32~104°F ± 1.8°F)
Outdoor Accuracy	60.1 ~ 80°C ± 0.8°C (140.2 ~ 176°F ± 1.4°F) 5.1 ~ 60°C ± 0.4°C (41.2 ~ 140°F ± 0.7°F) -19.9 ~ 5°C ± 1°C (-3.8 ~ 41°F ± 1.8°F) -40 ~ -20°C ± 1.5°C (-40 ~ -4°F ± 2.7°F)
Resolution	°C/°F (1 decimal place)
Display modes	Current
Memory modes	Historical data of past 24 hours, daily Max/Min
Alarm	Hi/Lo temperature alert
Indoor/Outdoor Humidity	
Humidity unit	%
Display range	1 ~ 99%
Indoor Accuracy	20~39% or 71~90% RH ± 8%RH @ 25°C (77°F) 40~70% RH ± 5%RH @ 25°C (77°F)
Outdoor Accuracy	1 ~ 20% RH ± 6.5% RH @ 25°C (77°F) 21 ~ 80% RH ± 3.5% RH @ 25°C (77°F) 81 ~ 99% RH ± 6.5% RH @ 25°C (77°F)
Resolution	1%
Display modes	Current
Memory modes	Historical data of past 24 hours, Max/Min
Alarm	Hi/Lo Humidity Alert

Specifications (continued)

Wind Speed and Direction

Wind speed unit	<i>mph, m/s, km/h and knots</i>
Wind speed display range	<i>0 ~ 112mph, 50m/s, 180km/h, 97knots</i>
Resolution	<i>0.1mph, 0.1m/s, 0.1km/h, 0.1knots</i>
Speed accuracy	<i>< 5m/s: +/- 0.5m/s; > 5m/s: +/- 6% (whichever is greater)</i>
Display mode	<i>Gust/Average</i>
Memory modes	<i>Historical Data of past 24 hours, Max Gust/Average</i>
Alarm	<i>Hi Wind Speed Alert (Average/Gust)</i>
Wind direction resolutions	<i>16 directions</i>

Rain

Unit for rainfall	<i>mm and in</i>
Accuracy for rainfall	<i>± 7% or 1 tip</i>
Range of rainfall	<i>0 ~ 19999mm (0 ~ 787.3 in)</i>
Resolution	<i>0.254mm (0.01in)</i>
Display modes	<i>Current</i>
Memory modes	<i>Historical Data of the past 24 hours, Max</i>
Rainfall display mode	<i>Hourly/Daily/Weekly/Monthly/Total rainfall</i>
Alarm	<i>Hi Daily Rainfall Alert</i>

Weather Index

Weather index mode	<i>Feels like, Wind Chill, Heat Index and Dew point</i>
Feels like range	<i>-40 ~ 50°C</i>
Wind chill range	<i>-40 ~ 18°C, wind speed >4.8km/h</i>
Heat index range	<i>26 ~ 50°C</i>
Dew point range	<i>-20 ~ 60°C</i>
Display modes	<i>Current</i>
Memory modes	<i>Historical Data of past 24 hours, Max/Min</i>

5-in-1 Wireless Outdoor Sensor

General

Dimensions (W × H × D)	<i>343.5 × 393.5 × 136mm (13.5 × 15.5 × 5.35in)</i>
Weight	<i>734g (with batteries)</i>
Main power	<i>3 × AA size 1.5V batteries (Lithium batteries recommended)</i>
Weather data	<i>Temperature, Humidity, Wind speed, Wind direction and Rainfall</i>
RF transmission range	<i>150m</i>
RF frequency	<i>917Mhz (AU)</i>
Transmission interval	<i>12 seconds for wind speed and wind direction data, 24 seconds for temperature, humidity and rain data</i>
Operating range	<i>-40 ~ 60°C (-40 ~ 140°F) Lithium batteries required</i>

Weather Underground is a registered trademark of The Weather Channel, LLC, both in the United States and internationally. The Weather Underground Logo is a trademark of Weather Underground, LLC.





**Thanks for being a
#SMARTGARDENER**



We really appreciate having you as a customer, and would like to say thank you for choosing us.

We recommend registering your new product on our website. This will ensure we have a copy of your purchase and activate an extended warranty. Keep up to date to with relevant product information and special offers available through our newsletter.



www.holmanindustries.com.au/product-registration/

Thanks again for choosing Holman

HOLMAN

For the #SMARTGARDENER   