

HOLMAN

Solar Weather Centre With Wireless Weather Vane



Solar Powered
Outdoor Weather
Data Collector



Indoor Receiver

Instruction Manual



Product Code: WS5056C



TECHNICAL DETAILS

Thank you for purchasing the Holman 5056 Solar Powered Weather Station. The system consists of a data gathering Solar Powered outdoor weather collector which is mounted on the outside of your home and transmits the collected data wirelessly to a pad inside the house that displays all the readings and results.

Please read the operating instructions carefully to familiarise yourself with the features and modes of operation before using the instrument.

Package Contents

Carefully unpack and remove the contents:

- 1x weather station main Indoor unit
- All in one data collector with solar panel
- 1x stainless steel mast
- Stainless steel accessory for fixing
- 1x battery charger
- 1x lithium LIPO battery

Technical Details

- Six keys: MODE,+, -, IN, OUT ,SNOOZE/ LIGHT
- Time display in 12hr or 24hr format
- Continuous perpetual calendar up to 2099
- Display of Date, Month and Day of week
- Day of week display in English only
- Dual alarm with snooze function (5 minute alarm interruption)
- 5 weather forecast: sunny, partly sunny, cloudy, rainy, storm
- Barometer and bar of 12 hours history for air pressure
- Indoor /outdoor temperature and humidity with trend
- Max./min. of temperature and humidity
- Thermometer measuring range inside: 0°C to +50 °C , outside -20°C~60 °C
- Temperature display elective in °C or °F
- Living space humidity
- Moon phase
- Wind speed in mph /kmh, wind speed 0~256kmh
- Wind direction in 16 directions
- Rainfall in mm and inch and display of 1hour, 24hour, TOTAL (0~999.99mm)
- UV index
- LUX display (0~120K LUX)
- Feel like
- Dew point
- Wind Chill
- Heat index
- Low battery indication for indoor
- Blue background illumination LED.
- Main unit batteries: 2 x AA, LR06, 1.5V

INSTALLATION

All in one outdoor data collector , solar powered

- Frequency: 917MHz
- Transmission range: 100 meters in open area.
** Actual distance may be varied depending upon the environment, and can be shortened by interference such as concrete walls.
- Solar powered + built-in Rechargeable battery: 3.7V, 1800mAh

Installation

- **Already fitted with Lithium Poly (LIPO) rechargeable battery.**
- Open the battery cover located at the back of the main unit and remove LIPO battery and charge it with the charger supplied. This should not take longer than one hour.

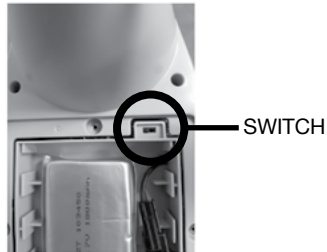
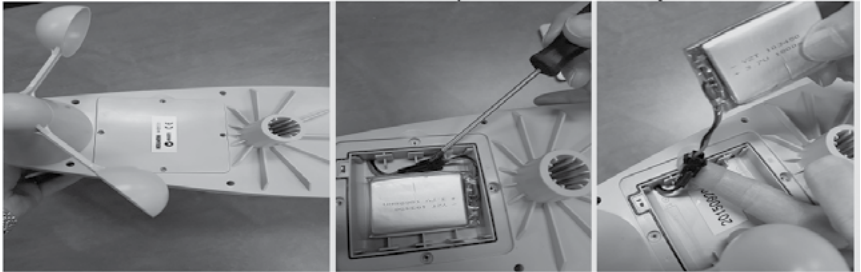

- Before closing the battery cover, push the inside black switch from OFF to ON (very important) , and check if the red LED light is flashing when the switch is turned to ON, this means the transmission is working. Then close the battery cover properly.
- The red LED light will flash approximately every 1 minute when transmitting the signal to the inside main unit.

The Indoor Receiver

- The Indoor Receiver can be placed onto any flat surface or wall mounted at the desired location by the hanging hole, It is important to check that the radio signal can be received before mounting.

OUTDOOR DATA COLLECTOR / MANUAL SETUP

Mounting the outdoor weather data collector onto the stainless steel mast

For accurate results, the outdoor data collector metal pole should be securely mounted onto a horizontal surface where it is at least 1 meter above the ground, and in an open area away from trees and other coverings where rainfall or wind speed may be reduced and cause Inaccurate readings.

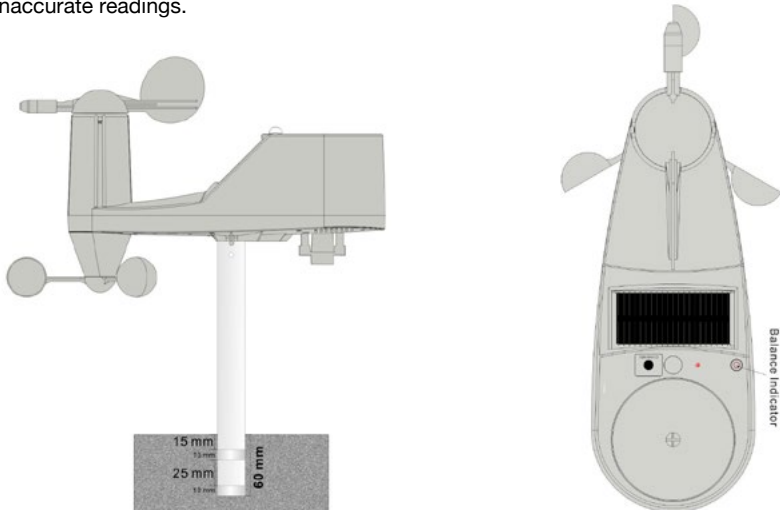

Note:

1. Please ensure that the wind speed and wind direction arms are free to move and not touching or resting on anything nearby.
2. There is marks W,S,E,N on the shaft of the wind sensor, please make sure the “N” points to the North direction.
3. Set-up the indoor receiver and outdoor data collector in an OPEN as possible area. This means trying to avoid concrete walls or anything that may cause interference between the two units as this may shorten the transmission distance.
4. Set-up the outdoor data collector in a very open area outside, in the direct sunlight, avoid shaded areas as this will cause the UV to read incorrectly.
5. Position the bubble in the middle of the level Indicator, this is important to ensure the rain gauge and wind measurements are accurate.
6. Fix the metal pole as our above picture illustrates , make sure the metal pole is mounted no more than 60mm below the surface, this is to ensure that the wind sensor has room to move around freely.

LCD DISPLAY

LCD overview

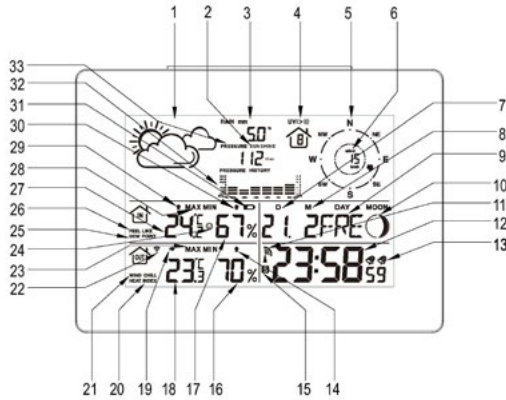

- | | | |
|---|---|---|
| 1. Weather | 15. Summer/Winter time symbol (not applicable in Australia) | 27. Indoor temperature |
| 2. Sunshine for LUX | 16. Outdoor humidity | 28. Max/Min for indoor temperature and humidity |
| 3. Rain | 17. Indoor humidity | 29. Indoor temperature trend |
| 4. UV index | 18. Outdoor temperature | 30. Indoor humidity trend |
| 5. Wind direction | 19. Outdoor temperature trend | 31. Indoor low battery |
| 6. Wind speed | 20. Heat index | 32. Bar of 12 hour air pressure history |
| 7. Date | 21. Wind chill | 33. Air pressure reading. |
| 8. Month | 22. RF symbol | |
| 9. Day of week | 23. Max/Min for outdoor temperature and humidity | |
| 10. Moon phase | 24. Living face | |
| 11. Radio controlled symbol (this is not applicable in Australia) | 25. Dew Point | |
| 12. Time | 26. Feel Like | |
| 13. Alarm | | |
| 14. Outdoor humidity trend | | |



F

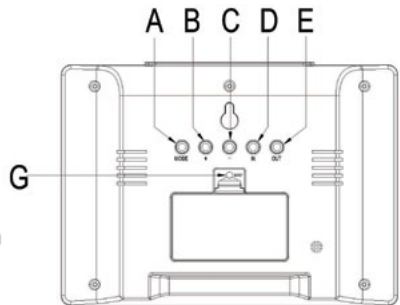

A=MODE B=+ C=- D=IN E=OUT F=SNOOZE/LIGHT G=reset

OUTDOOR WEATHER VANE / INITIAL OPERATION

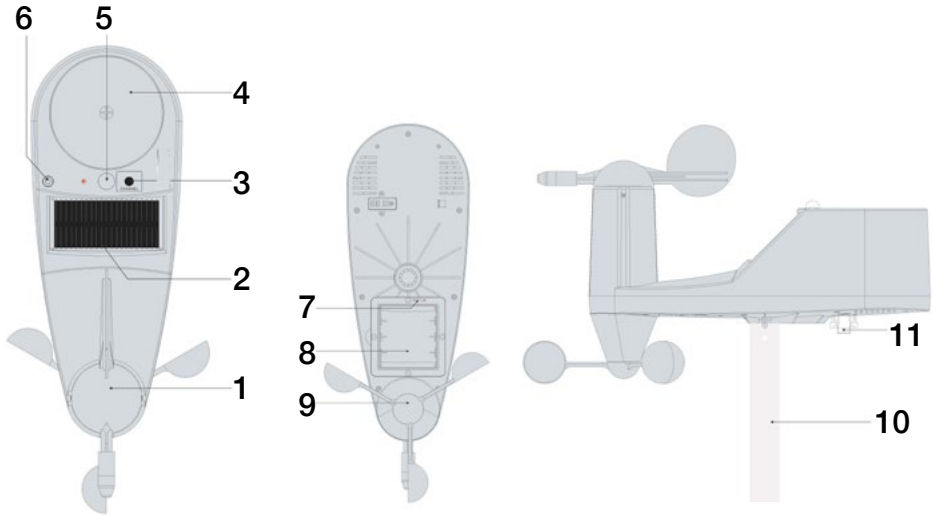

1. Wind Direction 2 .Solar panel 3. RF channel (hold for transmitting RF signal)
4. Rain gauge 5. UV index and LUX sensor 6. Level indicator (to judge if set up horizontally) 7. ON/OFF for power 8. Built-in rechargeable battery 9. Wind speed sensor 10. Metal pole 11. Cover for thermometer and hygrometer

Initial Operation

- Charge the LIPO battery
- Turn on the switch
- After turning on the switch, the main unit will connect with the outdoor data collector by RF signal.
The RF signal symbol at the outside unit will flash.
- This process takes about 3 minutes. Then the display shows the outdoor temperature/humidity/wind speed/wind direction/rain fall/UV index, in case of failure of reception, please press“OUT “for more than 3 seconds to receive again.

INITIAL OPERATION / ALARM

Manual time set-up

Please Note:

The clock automatically changes from set-up mode to time display mode if no keys are pressed for 20 seconds. Press and hold MODE key for 3 seconds to get back to set up mode

- Press and hold key "MODE" for 3 seconds.
- The 12hr/24hr will be flashing. Use "+ " and "- " to select
- Press "MODE " to confirm.
- The DM(date/month/MD(month/date) will be flashing, Use "+ " and "- " to select
- Press "MODE " to confirm.
- The display for the month will be flashing. Use "+ " and "- " to select the month.
- Press "MODE " to confirm.
- The display for the date will be flashing. Use "+ " and "- " to select the date.
- Press "MODE " to confirm.
- The display for the hour will be flashing. Use "+ " and "-" to select the hour.
- Press "MODE " to confirm.
- The display for the minutes will be flashing. Use "+ " and "- " to select the minutes..
- Press "MODE " to confirm.
- The C/F for temperature will be flashing, Use "+ " and "- " to select .
- Press "MODE " to confirm.
- The hpa/inhg for air pressure will be flashing, Use "+ " and "- " to select.
- Press "MODE " to confirm.
- The mm/inch for rainfall and kmh/mph for wind speed will be flashing, Use "+ " and "- " to select .
- Press "MODE " to confirm.
- Please follow the above steps to choose individual settings, such as 12/24hour , C/F, languages etc.

Daily alarm set-up

- Press "MODE" to switch from time display to A1 display
- Press and hold the key "MODE" for 3 seconds ,the alarm time is shown
- The hour display of the alarm time is flashing. Use "+ " and "- " to select the hour then follow with the minutes. Use "+ "and "- " to select.
- Press "MODE" to confirm.
- Follow the same setting for A2.

SNOOZE / TIME / TEMPERATURE

Daily alarm on/off

When in the mode of A1:

- Press “-“ to activate the alarm 1
- Press “_“ twice cancel the alarm 1.
- Follow the same setting for alarm 2.

Information:

- The clock automatically changes from set-up mode to time mode if no keys are pressed for 20 seconds.
- The alarm sounds for 2 minutes if no key is pressed to stop it.

Snooze function

To activate the snooze function, follow the steps below

- Press the key “SNOOZE/LIGHT“, while the alarm sounds, to activate the snooze function.
- If the snooze function is activated, alarm symbol is flashing.
- The alarm repeat after 5 minutes.
- The snooze function can be stopped by pressing any key.

12/24 hours mode

The time display can be in 12hr AM/PM or 24 hour mode, please follow the manual set-up to select

°C/°F temperature display

The temperature display can be in °C or °F, please follow the manual set-up to select.

Max./ Min. for the indoor/outdoor temperature and humidity

Press “+“ for displaying of indoor/outdoor max./min. of temperature and humidity, hold “+“for more than 3 seconds to clear up the max./min.

Trend arrow for the indoor/outdoor temperature and humidity

There are flat, up and down arrows for the trend of the temperature and humidity

FORECAST / WIND DIRECTION / RAINFALL

Weather forecast

Sunny Slightly Sunny Cloudy Rainy Storm

Please Note: The changing of the barometric pressure is used to predict the coming weather. The forecast is an indication and the pictures can at times be incorrect.

Barometer and bar and data of history for the past 12 hour of air pressure.

The previous 12 hours shown on the bar graph are an indication of the rising or falling in atmospheric pressures.

Air pressure can be read in hPa and inHg.

Hold "IN" for exchange of Sunshine and air pressure reading.

Air pressure setting and weather icon selection by SNOOZE/LIGHT button

The air pressure reading can be adjusted by holding the SNOOZE/LIGHT for 3 second, the altitude will be flashing, press "+" or "-" to adjust. Then press SNOOZE/LIGHT again, the weather icon will be flashing, press "+" or "-" to select weather picture, press SNOOZE/LIGHT to confirm.

Wind speed in mph/kmh

The wind speed can be shown in mph and kmh, and will record from 0 to 256kmh. Please follow the manual set-up to select mph/kmh, the display of the wind speed is updated every 1 minute.

Wind direction

There will be 16 wind directions, the display of the direction is updated every 1 minute.

Rainfall display

- Rainfall can be shown in mm and inch, and will record from 0 to

UV INDEX / DEW POINT / HEAT INDEX

999.99mm. Please follow the manual set-up to select the mm/inch.

- Press “-“ to show the rainfall in 1 hour, press twice for 24 hours, then 3 times for TOTAL.
- Press “-“ for more than 3 seconds to clear up the volume accordingly, such as, if showing 1 hour, this clears the data in 1 hour display, others unchanged, if showing 24 hours, clear up the data in 24 hour display, others unchanged.
- The max. amount of rainfall that will be recorded is 999.99mm (99.99inch), the display will flashing when the max has been reached, you will need to manually clear out the data, otherwise, the data will no longer record.
- To manually clear the Total rainfall, select the Total setting and hold the minus button in for 3 seconds or more and the display will disappear.

NOTE: The rainfall measurements update at midnight. If this is inconvenient it is best to make the clock 12 hours out of sync - i.e. PM instead of AM. Then the update occurs at 12noon. So it is easy to see the last 24 hours rain reading.

Sunshine LUX reading

The range for LUX is 0~120KLUX

Hold “IN “for exchange Sunshine and air pressure reading.

UV Index

The UV index will be display.

Feel like and Dew point

Press “IN “ to check the DEW POINT and FEEL LIKE

Wind chill and Heat Index

Press “OUT “ to check the HEAT INDEX and WIND CHILL

Illumination

Press the key “SNOOZE/LIGHT“ to activate the display illumination for 10 seconds.

MOON PHASE / LIVING SPACE HUMIDITY

Moon phase display

The weather station uses saved data to show the moon phase

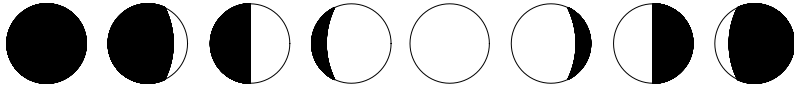

A

B

C

D

E

F

G

H

A: New moon

B: Increasing crescent

C: First half

D: Increasing 3/4

E: Full moon

F: Decreasing 3/4

G: Last half

H: Decreasing crescent

Living space humidity

The weather station uses saved data to determine the humidity in the living space and shows the respective symbols.



comfortable, dry,

humid

Low battery condition display

The weather station displays the low battery condition symbol to remind you the batteries of the indoor receiver need to be exchanged.

There will be an unhappy face displayed in between the indoor temperature and humidity readings, this will mean the batteries need to be replaced.

RF connection to the outdoor data collector

Press and hold the key "OUT" for 3 seconds to search for outdoor data collector, the RF signal symbol at the outside area will flashing when trying to connect. RF reception is weaker in rooms with concrete walls (e.g. in the basement) and in office buildings, the distance will be shortened if have interference. For extreme cases, please put the main unit near a window.

WARRANTY



Solar Powered
Outdoor Weather
Data Collector



Indoor Receiver

Should you have any questions about this product or its operation please telephone our customer service help line on **1300 716 188**.

Holman offer a **1 year** replacement warranty from the original date of purchase.

To claim warranty the product must be returned with a copy of the original receipt.

We will honour all statutory guarantees that this product is of acceptable quality (Including that it is fit for purpose).



HOLMAN INDUSTRIES

11 Walters Drive,
Osborne Park,
Western Australia 6017.
Ph: 1300 716 188

www.holmanindustries.com.au