

HOLMAN

Dial Ezy



IRRIGATION CONTROLLER 4 or 6 Station Model

INSTRUCTION MANUAL

SUITABLE FOR INDOOR USE ONLY OTHERWISE WARRANTY IS VOID

N10372

CE

1
year
guarantee

Table Of Contents

Features	1
Glossary	2
Programming Instructions	
Introduction	3
Programming Example	4
Other Functions	5
General tips for programming	5
Programming	
Set Current Time & Correct Day	6
Set Calendar (Optional)	6
Step 1. Set Start Times	7
Step 2. Set Watering Days	8
Individual Day Selection	8
Odd / Even Day Selection	8-9
Interval Day Selection	9
Step 3. Set Station Run Times	9-10
Manual Operations	
System test facility	11
Run A Single Station	11
Run A Program	12
Other Features	
Stop	12
Stacking Start Times	12
Automatic BackUp Program	12
Fitting a Rain Sensor (Optional)	13
Rain Off Mode	14
Water Budgeting	14
Installation Instructions	
Mounting The Controller	15
Electrical Hook-Up	15
Field Wiring Connections	16
Terminal Block Layout	16
Power Supply Connections	17
Connection Of Valves	17
Pump Hook-Up Connections	18
Electrical Characteristics	19
Servicing The Controller	20
Fault Finding Guide	21
Spare Watering Planners	22-23

Features

This unit is available in a 4 or 6 station configuration. Designed for residential applications, this controller has four separate start times and each can be programmed individually to suit your watering needs.

These different areas may require individual watering programs and often use different types of sprinklers.

Examples: Turf areas generally use pop-up sprinklers and require less frequent but heavier watering. However, flower beds use micro sprays and require more frequent watering. The valves (stations) which water similar garden areas are often *grouped together and put into the same start/program as they need to be watered on the same days.*

These stations (valves) will water in sequential order from the lowest number at the start time (or times) nominated and on the days selected. Maximum watering duration for a station (valve) is 12 hours and 59 minutes.

This controller has a 7 day calendar with individual day selection, even, odd + odd-31 and interval days from 1 to 15.

A key water saving feature is the installation of a rain sensor. This controller has a rain sensor switch in the fascia so you can enable or disable the rain sensor control function.

Glossary

Indoor Controller Model

Selection Dial

Used for operations & programming.

LCD Display

Easy to read display.

Programming Buttons

Used for adjusting the programmed information.

Rain Sensor Switch

Manually activate rain sensor by switching to ON/OFF position.

Fuse Location

Remove cover to access fuse

Terminal Cover

Remove to access terminals for solenoid (valve) wires and to annually replace 9 volt block battery.



Programming Instructions

Introduction

This controller has been designed with four separate starts (programming schedules), to allow different garden areas to have their own individual watering requirements.

A program is basically a method of grouping stations (valves) with similar watering requirements to water on the same days. These stations will water in sequential order from the lowest number at the start time (or times) nominated and on the days selected. The stations can have different durations.

The key elements when programming your controller are:

1. Grouping the stations. (valves)

Group together garden areas which have similar watering requirements. Examples are: Turf Areas, Flower Beds, Pergola/ Undercover Areas, or Vegetables. These different groups require individual settings (programs).

2. Planning out your watering program.

Complete your individual watering planner, supplied at the back of this book.

3. Setting the current time and correct day of the week.

4. Setting an automatic program.

Use the following 3 steps to set each group.

4.1 Set Start(s).

This sets the time of the day when the watering program will commence.

4.2 Set Watering Days.

These are the nominated days when the automatic system will be active.

4.3 Set Station Run Times.



This sets the watering duration required for each station (valve).

Programming Instructions

Programming Example

A typical 6 station system is illustrated below. This guide will assist you when completing your watering planner. In this example the lawn areas are using pop-up sprinklers & require less frequent watering.

The vegetables are watered using drippers, with a longer run time & the flower beds/pergola areas are watered with micro spray nozzles. Each area is put into a separate program.

VALVE NUMBER & LOCATION					
1	FRONT LAWN	4	GARDEN BEDS		
2	FRONT LAWN	5	BACK LAWN		
3	VEGETABLES	6	PERGOLA		
PROGRAM					
	START TIME	WATERING SCHEDULE	STATION	RUN TIME (minutes)	
1	Start Time 1: 4:00am	MONDAY WEDNESDAY FRIDAY	1	20	
			2	20	
			3		
			4		
			5	20	
			6		
2	Start Time 2: 6:00am	MONDAY WEDNESDAY FRIDAY SUNDAY	1		
			2		
			3	30	
			4		
			5		
			6		
3	Start Time 3: 5:00am	TUESDAY THURSDAY SATURDAY	1		
			2		
			3		
			4	10	
			5		
			6		
4	Start Time 4: 7:00am	MON, TUES WED, THURS FRI, SAT SUN	1		
			2		
			3		
			4		
			5		
			6	5	

Programming Instructions

Other Functions

This controller can also manually run a selected start once, or an individual station can be set to run once from 1 minute up to 12 hours and 59 minutes. During winter the automatic start times can be suspended to prevent watering while it is raining. A test facility for checking the valves and sprinklers is also provided.

General tips for easy programming:

Tips to help eliminate programming confusion.

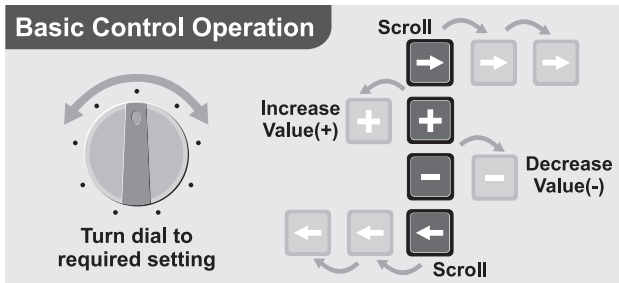

- Complete the spare watering planner.
- When setting, one push of the button will increment one unit.
- Holding one button down will fast scroll through the units.
- During programming, only the flashing values are able to be set.
Adjust using **+** or **-** buttons.
- Pressing **→** will scroll forward through the settings in an orderly sequence.
- Pressing **←** will scroll back to previous settings and flashing values can be changed.



Programming

Set Current Time & Correct Day

Turn the dial to **Set Clock/Calendar** position.

The minutes will be flashing. Use  or  to adjust.

Press the  button and the “hours” will flash.



Use  or  to adjust. Note: AM / PM must be set correctly.

Press  and the “day of the week” will flash.

Use  or  to set correct day.

Set Calendar (Optional)

Note: The calendar only needs to be set when selecting ODD/ EVEN day watering in areas where water restrictions may require this feature.

Press  button until the year, month & day are shown. The “year” will be flashing. Use  or  to adjust.

Press  button and the “month” will flash.

Use  or  to adjust.

Press  and the “day” will flash.

Use  or  to adjust.

TIP To return to the clock, press , or turn dial to another position.

Before proceeding, ensure your watering planner has been completed. From this, you should be aware of which stations are allocated to each program.

Note: Set one program at a time – this will ensure that all the values are entered correctly.

Programming

Setting Start

Each start time can be programmed individually to suit your watering requirements

STEP 1. Set Start Times

All valves will activate in sequential order for each start time. Turn the dial to **Set Start Times**.



The display will show:







“Start 1” will flash.

Press  & the “hour” will flash. Use  or  to adjust.

Note: AM / PM is set correctly.

Press  & the “minutes” will flash. Use  or  to adjust, if required.

TIP To turn an active start time off, turn the dial to the **Set Start times** position, *Select* the start number required using the  button and then **press**  until the “hour” is flashing.

Use  or  until “OFF” is shown.

TIP “OFF” position is between 12 and 11pm.

Programming

STEP 2. Set Watering Days

This unit has a 7 day calendar with individual day selection.

Turn the dial to **Set Watering Days**.

Individual Day Selection





This is the **selectable** day option.

The display will show:

This refers to Mon being Day 1.



To turn Monday off, **press** button . To leave Monday active, leave as is & advance to Tuesday (day 2) by **pressing** the  button.



Again **press** the  button to set the day off if required followed by  to advance. Continue until all seven days have been set "ON"  or "OFF" .

Odd / Even Day Selection (Optional)

In some regions, users are only allowed to water their gardens on ODD dates if their house number is ODD, or on EVEN dates when their number is EVEN.

This controller allows this to be done simply by setting the relevant selection of ODD or EVEN and setting the current date into the controller. The controller will account for leap years.

Programming

If you require the ODD / EVEN day option, simply **press** the  button until “EVEN” is shown. **Press** the  button and “ODD” will be shown. Press the  button and “ODD-31” . This feature may be required in areas where water restrictions are enforced. Note: Remember to set the 365 day calendar when setting the clock, or this feature will be out of sequence.

Interval Day Selection

“Interval 1” will be flashing.

This means that watering will occur every day.

To change the interval day, press the  button.

Examples: Interval 2 means watering will take place every second day, 3 means watering will be every third day etc.

Interval watering can be set from everyday to every 15th day. The Run Day refers to the number of days before the next watering program will occur.



STEP 3. Set Station Run Times

This is the length of time that each station (valve) is set to water on a particular program. Maximum watering time is 12 hours 59 minutes for each station. A station can be assigned from 1 to 4 starts if required, with different run times. Set one start at a time

Turn the dial to the **Set Station Run Times** position and the display will show the following.

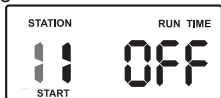



This means station 1 is set to “OFF” in Start 1. “Station 1” will be flashing.

Programming

To adjust the **Run time** in minutes **press** , and use  or .

To set the run time in hours, **press**  and “0” will appear and flash.

To adjust use  or .

If not required, **press** , and advance to station 2 by pressing the  button.

Continue until all the stations in Start 1 have been set with a run time, or if a station (or stations) are not required to be active in this particular program, ensure that the run time is set to “OFF”.

Note: To set a station to “OFF”.

Use  when the “**RUN TIME**” is flashing.

This completes the setting up procedure for automatic watering of start 1.

STEP 3. Set Station Run Times. (Continued)

Should you need a second start Start.

Turn the dial to “Set Start Times” and “Start 1” will flash.

Press  and change to Start 2 position and follow the same 3 steps to set an automatic watering program.

1. **Set Start Time**
2. **Set Watering Days**
3. **Set Station Run Times**

TIP Remember to return the dial to the “AUTO” position after completing the set up of an automatic program.

This will ensure that the automatic cycles will take place.

Manual Operations

System Test Facility

Turn the dial to **Run System Test**.

There will be a one second pause

The display will show:

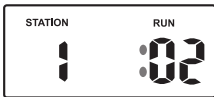

Use this feature to check that your valves & sprinklers are working correctly. The unit will run all stations in sequential order. The factory preset time of 2 minutes per station can be adjusted. The new adjusted run time will become the new default time.

Use or to adjust and to advance.

TIP If the water supply is from a pump system, it is critical to ensure all outputs are connected to a valve. Any output NOT connected to a valve, should be linked back with a wire to the nearest output **with** a valve.

This prevents the pump running against a closed head.

USE ONLY 1 AMP FUSE M-205

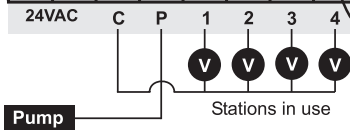

Unused stations linked back to last used station.

Run A Single Station

Turn the dial to **Run Single Station**. There

will be a one second pause. Use to

advance to the required station and to

adjust the run time, then or .

Maximum run time is 12 hours 59 minutes.



Manual Operations (cont.)

Run A Start

To manually run a complete start once for the run times as set in the automatic schedule, **turn** the dial to the **Run a Start** position. "Start 1" will be shown in the display. To run start 1, leave, or advance to start 2 by **pressing**



Other Features

Stop

To stop an automatic or manual watering schedule, **turn** the dial to the **Off** position.

TIP For automatic watering, remember to **turn** the dial back to the **Auto Run** position. The **Off** position will stop any watering from occurring.

Stacking Start Times

Should you accidentally set the same watering start time on more than one program, the controller will stack them in sequential order from the lowest number. All the programmed start times will be watered, but the start times will be shunted along.

Automatic Back Up Program

When the battery is not fitted or is flat during a power outage, The automatic program will be retained in a permanent memory chip. Also the clock time will be retained in the memory at the time of the outage.

A standard 9 volt alkaline block battery should be fitted to the battery snap supplied to maintain the clock accuracy and hold the automatic programs during power outs.

TIP The display has a warning indicator to let you know when the battery is low or not fitted. The word **BAT** is displayed under the AM / PM indicator in the clock mode.

Other Features

Fitting a Rain Sensor (optional)

A rain sensor can be wired directly into the terminal block. When the sensor is wet, all automatic and manual watering will not operate.

To fit a rain sensor follow this procedure:

1. The sensor switch, accessed on the fascia, must be up in the "ON" position. To over-ride the sensor when it is wet, simply move the sensor switch down to the "OFF" position. This will allow automatic and manual watering cycles to operate.



2. Connecting the rain sensor wires:

a) **Remove** the link connector by loosening both screws and slide out. (Link located under the terminal cover.)

b) Connect the two sensor wires into the terminal block and replace where the link was. Fasten one wire into the common (C), the other into the 24VAC. Polarity not applicable.

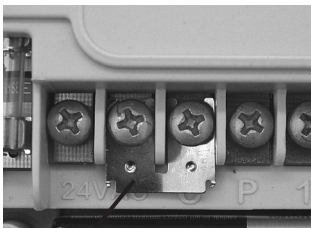

Remove link
connector

New Sensor wires

NOTE: Far left 24VAC Terminal is active.

TIP It is important to move the sensor switch back to the "ON" position after completing your manual watering cycle.

Other Features

Rain Off Mode

To stop the automatic watering cycles during winter, **turn** the dial to the **Off** position. The word “*Off*” will appear in the display. This means the automatic programs will not come on, but the programmed information is still retained in the memory. To re-activate the automatic start times, **turn** the dial back to the **Auto** position.

Installation Instructions

Mounting The Controller

This controller unit is an INDOOR MODEL and MUST NOT be exposed to rain or water ingress, or direct sunlight.

Install the controller near a 240V AC mains outlet, preferably located in a house, garage or other covered area. For ease of operation, eye level placement is recommended.

Drive one #8 screw into the wall, leaving about 4mm of the screw exposed. If necessary, use a toggle bolt or masonry shield.

Hang the controller from the key slot located in the back of the case. Make sure the head is properly seated inside the controller case. Additional screws may be inserted through the holes in the lower corners of the controller case.

Electrical Hook-Up

WARNING

- 1 All electrical work must be carried out in accordance with these instructions following all applicable Local, State and Federal codes, or warranty will be void.**
- 2 Disconnect mains power supply before maintenance work to controller or valves and when connecting and disconnecting field wiring and pump or master valve hook-ups.**

Installation Instructions

Field Wiring Connections

PREPARATION

1. Prepare wires for hook-up by cutting the wires to the correct length and stripping approximately 6mm (¼ inch) of insulation from the end to be connected to the controller.
2. Ensure terminal block screws are loosened sufficiently to permit easy access for wire ends. Insert stripped wire ends into the clamp aperture and tighten screws. *Do not over tighten* as this may damage the terminal block.
3. A maximum of 0.5 Amps may be supplied by any output. Check the inrush current of your solenoid coils before connecting more than two valves to any one station.

Terminal Block Layout

The terminal block is laid out as follows:

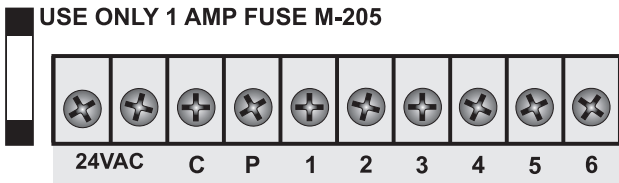

GLOSSARY

24VAC

24VAC Power Supply

C

Common valve wire input

P

Master valve or pump start active wire

ST1 to ST6

Station (Valve) active wire connection

Installation Instructions

Power Supply Connections

The controller itself can run off a 240V AC to 24V AC external transformer. It is recommended that the transformer is not connected to a 240V AC supply which is also servicing or supplying motors. (i.e. Air conditioners, pool pumps, refrigerators, etc.) Lighting circuits are suitable as a power source. Connections to the unit are as follows:

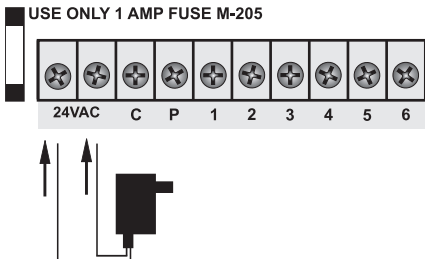

Connection Of Valves

Up to two 24VAC Solenoid Valves can be connected to each station output and wired back to the common (COM) thus:

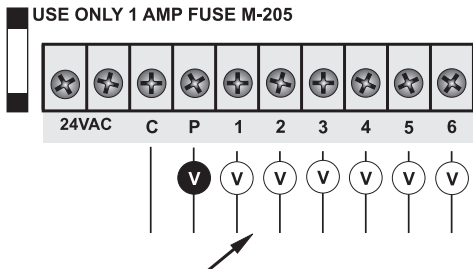

Valve wires can enter the controller through rear.

Installation Instructions

Pump Hook-Up Connections

DO NOT attempt to drive a pump starter directly from the controller. Pump start is provided by connecting one side of the coil of a suitable relay to the Master Valve/Pump Start output of the controller and the other side to the controller common.

For systems supplied with water from a pump, unused stations **MUST** be connected back to the last used station to eliminate the possibility of the pump running against a closed head.

Failure to do so could lead to pump damage!

The diagram shows an 6 station controller with **4 active** stations (valves):

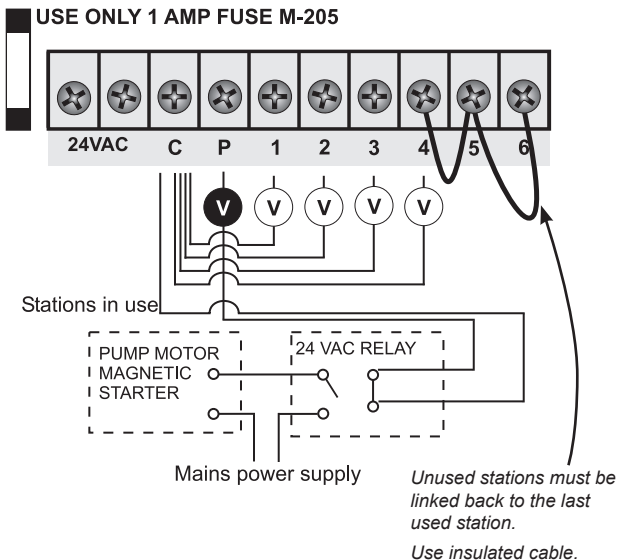

Electrical Characteristics

Power Supply

MAINS SUPPLY

This unit can run off a 50Hz external transformer, (plug pack), with an output of 24VAC 50Hz @ 1.0 Amp.

Plug Pack Model

The correct wiring installation for the 24VAC plug pack is shown on page 17. The plug pack model is suitable for **indoor installation only**.

Electrical Outputs

ELECTRICAL POWER SUPPLY

- Input: 24Volts AC 50Hz.
- Electrical Outputs: Maximum of 1.0 AMPS

To Solenoid Valves: 24 VAC 50/60 Hz 0.75 AMPS max.

To the Master Valve/Pump Start: 24VAC 0.25 AMPS (maximum)

Note: *Transformer and fuse capacity must be compatible with output requirements.*

Overload protection: Standard 20mm 1 Amp fuse.

Power failure: 9 Volt block type battery maintains clock & starts for up to 4-6 weeks. Permanent memory feature will hold the programs and last clock time during power outage, if the battery is not fitted or flat.

The output circuits should be installed and protected in accordance with wiring rules.

Servicing The Controller

The controller should always be serviced by an authorised agent.

Follow these steps:

1. Turn the mains power off to the controller.
2. Disconnect 24 Volt power leads from the plug pack at the controller 24VAC terminals.
3. Clearly mark or identify all valve wires according to the terminals they are connected to, (1 to 6). This allows you to easily wire them back to the controller, maintaining your valve watering sequence.
4. Disconnect valve wires from the terminal block.
5. Remove the complete unit from the wall.
6. Carefully wrap the complete unit in protective wrapping and pack in a suitable box. Return to your service agent or the manufacturer.



Note: Tampering with the unit will cancel the Guarantee.

7. Replace your controller by reversing this procedure.



Fault Finding Guide

Symptom	Possible Cause	Suggestion
No display.	Faulty transformer. Fuse blown.	Check fuse. Check field wiring. Check transformer.
Single Station not working.	Faulty solenoid coil.	Swap faulty station wire on controller terminal block with known working station wire. If the faulty valve still does not work on the known working connection then the solenoid coil is faulty. The panel may need to be repaired.
Fuse blows.	Incorrect wiring or bad wiring joint.	Check wiring and joints.
No automatic start.	Incorrect programming or blown fuse.	If unit works manually check settings. Check fuse and field wiring.
Buttons on keypad not responding.	Short on keypad or programming not correct.	Check instruction book to ensure programming correct. If keypad still not responding return panel to supplier or manufacturer.
System coming on at random.	Too many start times entered on automatic programs	Check number of start times entered and when they are scheduled to come on. If programming is correct return panel to supplier or manufacturer.
More than 1 station coming on at once.	Damaged main output driver chip.	Check wiring and swap faulty station wire(s) on controller terminal block with known working station wire. If the same outputs are still locked on, return panel to supplier or manufacturer.
Pump start chattering.	Faulty relay or pump contactor.	Electrician to check voltage on pump relay or contactor.
Display cracked or missing segments.	Display damaged during transportation.	Return panel to supplier or manufacturer.

Spare Watering Planner

VALVE NUMBER & LOCATION			
1		4	
2		5	
3		6	
PROGRAM			
	START TIME	WATERING SCHEDULE	STATION RUN TIME (minutes)
1	Start Time 1:		1
			2
			3
			4
			5
			6
			6
2	Start Time 2:		1
			2
			3
			4
			5
			6
			6
3	Start Time 3:		1
			2
			3
			4
			5
			6
			6
4	Start Time 4:		1
			2
			3
			4
			5
			6
			6

Spare Watering Planner

VALVE NUMBER & LOCATION					
1		4			
2		5			
3		6			
PROGRAM					
	START TIME	WATERING SCHEDULE	STATION	RUN TIME (minutes)	
1	Start Time 1:		1		
			2		
			3		
			4		
			5		
			6		
2	Start Time 2:		1		
			2		
			3		
			4		
			5		
			6		
3	Start Time 3:		1		
			2		
			3		
			4		
			5		
			6		
4	Start Time 4:		1		
			2		
			3		
			4		
			5		
			6		

Your Guarantee

The manufacturer Guarantees to the original purchaser that any product supplied by the manufacturer will be free from defects in materials and workmanship for a period of one year from the date of purchase. Any product found to have defects in material or workmanship within the period of this Guarantee shall be repaired or replaced by the manufacturer **free of charge**.

The guarantor does not guarantee the fitness for a particular purpose of its products and does not make any guarantee, expressed or implied, other than the guarantee contained herein. The guarantor shall not be liable for any loss from use of the product or incidental or consequential damages including damages to other parts of any installation of which this product is part.

The guarantee shall not apply to any equipment which is found to have been improperly installed, set up or used in any way not in accordance with the instructions supplied with this equipment, or to have been modified, repaired or altered in any way without the express written consent of the company. This guarantee shall not apply to any batteries or accessories used in the equipment covered under this guarantee or to any damage which may be caused by such batteries.

If the Controller develops a fault, the product or panel must be returned in adequate packing with:

- 1 A copy of your original invoice.
- 2 A description of any fault.

It is the purchaser's responsibility to return the Controller to the manufacturer or their agent by pre-paid freight.

HOLMAN INDUSTRIES

47 Walters Drive
Osborne Park
Western Australia 6017



Tel: +61 8 9204 1011 Fax: +61 8 9204 1013

Web: www.holmanindustries.com.au