

**HOLMAN**

ZEPHYR : WI-FI DATA IN  
YOUR OWN GARDEN



# Wi-Fi Weather Station





For additional support, please visit  
[www.holmanindustries.com.au/WS5092W](http://www.holmanindustries.com.au/WS5092W)  
or scan this QR code!

# Contents

Precautions	5
Overview	6
Tech Specs	6
Package Contents	7
Live Data Display Panel	9
Outdoor Sensor	10
Installation and Setup	11
Setup Summary	11
STEP i: Outdoor Sensor Setup	11
STEP ii: Display Panel Setup and Connection	12
STEP iii: Connecting to Holman Home	12
STEP iv: Mounting the Outdoor Sensor	15
STEP v: Manual Time Setup (if not connecting to Wi-Fi) and Configure Unit Settings (also available on the app)	16
Mounting the Display Panel (Optional)	16
Operation and Settings	17
Temperature Units °C/°F Selection	17
Daily Max/Min	17
Temperature and Humidity Trends	17
Air Pressure	17
Wind Speed and Direction	17
Rainfall	17
Index	18
Backlight	18
Baro History Graph	18
Moon Phase	18
Adjusting the Barometric Pressure Reading	19
Maintenance	20
Low Batteries	20
Outdoor Sensor Checks	20
Rainfall Sensor Access	20
Hygro-Thermo Sensor Access	21
Troubleshooting	22
Warranty	23



# Precautions

- i** Read through these instructions in their entirety before attempting to setup up your **Zephyr Wi-Fi Weather Station**
  - i** Do not subject the unit to excessive force, shock, dust, temperature or humidity
  - i** Do not cover the ventilation holes with any items such as newspapers, curtains etc.
  - i** Do not immerse components in water
  - i** If you spill liquid over any indoor components, dry immediately with a soft, lint-free cloth
  - i** Do not clean the unit with abrasive or corrosive materials
  - i** Do not tamper with the units internal components to avoid invalidating your warranty
  - i** Placement of this product on certain types of wood may result in damage to its finishing for which Holman Industries will not be responsible
  - i** Only use fresh non-rechargeable alkaline batteries. Do not mix new and old batteries
  - i** Risk of explosion if the battery is replaced by an incorrect type
  - i** Disposal of a batteries into fire or a hot oven, or mechanically crushing or cutting of batteries can result in an explosion
  - i** Leaving batteries in an extremely high temperature surrounding environment can result in an explosion or the leakage of flammable liquid or gas
  - i** Batteries subjected to extremely low air pressure may result in an explosion or the leakage of flammable liquid or gas
  - i** Only use genuine **HOLMAN** attachments or accessories available at [www.holmanindustries.com.au](http://www.holmanindustries.com.au) to ensure your warranty stays valid
  - i** Dispose of used batteries according your local recycling regulations
  - i** Ensure your **Display Panel** is installed near your power outlet and is easily accessible
  - i** The contents of this manual may not be reproduced without the permission of **Holman Industries**
  - i** Technical specifications and user manual contents for this product are subject to change without notice. We advise checking [www.holmanindustries.com.au](http://www.holmanindustries.com.au) for the latest information
  - i** This product is not a toy. Keep out of the reach of children
  - i** The **Display Panel** is intended to be used only indoors
  - i** Only use the supplied power adaptor to power your **Display Panel**
- ⚠ Risk of explosion if battery is replaced by an incorrect type**

The manufacturer and supplier cannot accept any responsibility for any incorrect readings, export data lost and any consequences that occur should an inaccurate reading take place. Any app images are subject to software updates and may differ from what is shown on the latest version of Holman Home. This product is designed for use in the home only as indication of weather conditions. This product is not to be used for medical purposes or for public information. iOS is a trademark of Apple Inc. Android is a trademark of Google LLC. The Android robot is reproduced or modified from work created and shared by Google and used according to terms described in the Creative Commons 3.0 Attribution License.



# Overview

## Tech Specs

---

### Live Data Display Panel

- ✔ Dimensions (W × H × D):  
197 × 123 × 25mm
- ✔ Weight: 430g
- ✔ Input Power: DC 5V, 1.2A adaptor
- ✔ Backup Battery: 3 × AAA size, 1.5V Alkaline, non-rechargeable (not included)
- ✔ Wi-Fi Standard: 802.11 b/g/n
- ✔ Wi-Fi Operating Frequency: 2.4GHz
- ✔ Supported Router Security Type:  
WPA/WPA2, OPEN, WEP
- ✔ Backlight: White LED
- ✔ Graphic History: Barometer
- ✔ Low Battery Indicator: Indoor/Outdoor
- ✔ Outdoor Sensor RF Frequency: 917MHz
- ✔ Outdoor Sensor RF Range: 100m line-of-sight
- ✔ Time Display: HH:MM:SS
- ✔ Time Alarm: Dual with 5 minute snooze
- ✔ Hour Format: 12hr AM/PM or 24 hr
- ✔ Date Display: Day, Month and Day of Week
- ✔ Time Synchronisation: Internet time server
- ✔ Barometer Units: hPa and inHg
- ✔ Barometer Measuring Range:  
850 ~ 1050hPa (accuracy ±5hPa)
- ✔ Weather Forecast:  
Sunny, Partly Sunny, Cloudy, Rainy, Storm
- ✔ Temperature Units: °C and °F
- ✔ Indoor Temperature Range:  
-10°C ~ 50°C (±1°C accuracy)
- ✔ Temperature Alarm:  
High/Low temperature alert for Indoor and Outdoor
- ✔ Humidity Units: %
- ✔ Humidity Range: 20% ~ 95% (accuracy ±5%)
- ✔ Wind Speed Units: km/h, mph
- ✔ Wind Speed Display Range:  
0 ~ 215km/h (accuracy: ±10%)
- ✔ Wind Direction Display Mode: 16 directions
- ✔ Rainfall Units: mm and in
- ✔ Rainfall Display Mode: Today (as of 9am), Yesterday,  
Total (0-999.9mm, accuracy <15mm: ±10%,  
accuracy 15-999.9mm: ±7%)
- ✔ Moon Phases: Full Moon, Waning Gibbous, Third  
Quarter, Waning Crescent, New Moon, Waxing  
Crescent, First Quarter, Waxing Gibbous
- ✔ Weather Index Modes: Feels Like (-65°C ~  
50°C) / Wind Chill (-65°C ~ 18°C) / Heat Index  
(26°C ~ 50°C) / Dew Point (-20°C ~ 60°C), out  
of display range will read LL (low) or HH (high)

### Outdoor Sensor

- ✔ Dimensions (W × H × D): 396 × 313 × 151mm
- ✔ Weight: 988g
- ✔ Connection Frequency: RF 917MHz
- ✔ Connection Range: 100m line-of-sight
- ✔ Operating Temperature Range  
-40°C ~ 70°C (+/-1°C accuracy)
- ✔ Input Power: 3 x AA size, 1.5V  
Alkaline batteries (not included)

# Overview (continued)

## Package Contents



1. All-in-One **Outdoor Sensor**
2. Live Data **Display Panel**
3. Stainless steel mounting pole (fasteners included)
4. Power cable for **Display Panel**

Model no: WS5092W

# Overview (continued)

## Live Data Display Panel

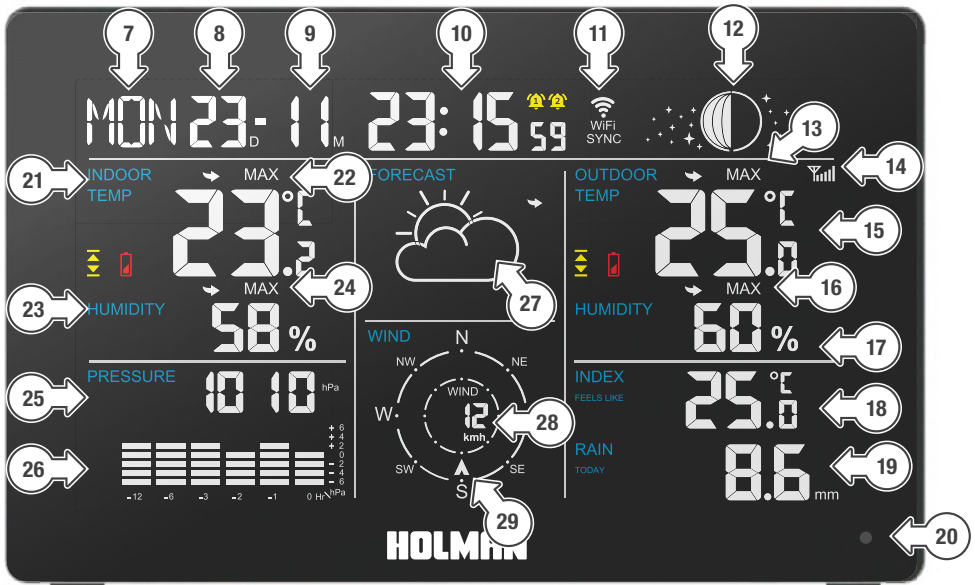



# Overview (continued)

- |                                   |   |  |                              |
|-----------------------------------|---|--|------------------------------|
| 1. <b>MODE</b>                    | 13. Outdoor temp min/max indicator                                      | 21. Indoor Sensor temperature with trend, alert, and battery indicator | 29. Wind direction indicator |
| 2. <b>SEARCH</b>                  | 14. RF connection indicator   | 22. Indoor temp min/max indicator                                      | 30. Stand                    |
| 3. <b>SNOOZE/LIGHT</b>            | 15. Outdoor Sensor temperature with trend, alert, and battery indicator | 23. Indoor humidity with trend   | 31. AAA battery compartment  |
| 4. <b>+</b>                       | 16. Outdoor humidity with trend   | 24. Indoor humidity min/max indicator                                  | 32. Hygro-thermo detector    |
| 5. <b>-</b>                       | 17. Outdoor humidity min/max indicator                                  | 25. Air pressure   | 33. 5.0V, 1.2A power jack    |
| 6. <b>WIFI</b>                    | 18. Index   | 26. Barometric Graphic History   |                              |
| 7. Day                            | 19. Rainfall  | 27. Forecast indicator   |                              |
| 8. Date                           | 20. Wi-Fi indicator LED   | 28. Wind speed   |                              |
| 9. Month                          |   |  |                              |
| 10. Time with alarm indicators    |   |  |                              |
| 11. Time sync and Wi-Fi indicator |   |  |                              |
| 12. Moon phase indicator          |   |  |                              |

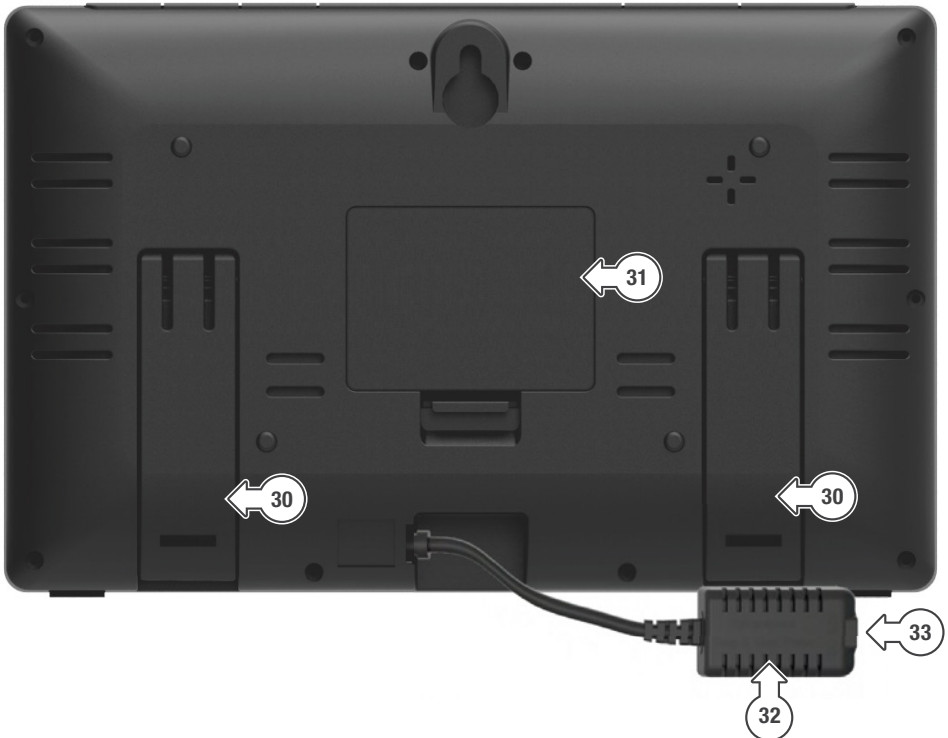

# Overview (continued)

## Outdoor Sensor

1. Wind vane
2. Wind speed sensor
3. Hygro-Thermo sensor
4. Stainless steel pole
5. RF indicator LED
6. Sync button
7. Rainfall sensor access screw
8. Rainfall sensor
9. Battery compartment
10. Balance spirit level
11. Rain gauge cup

**i** Rainfall sensor (8) can be removed periodically for cleaning purposes

**!** Do not carry by the wind vane or wind speed sensors

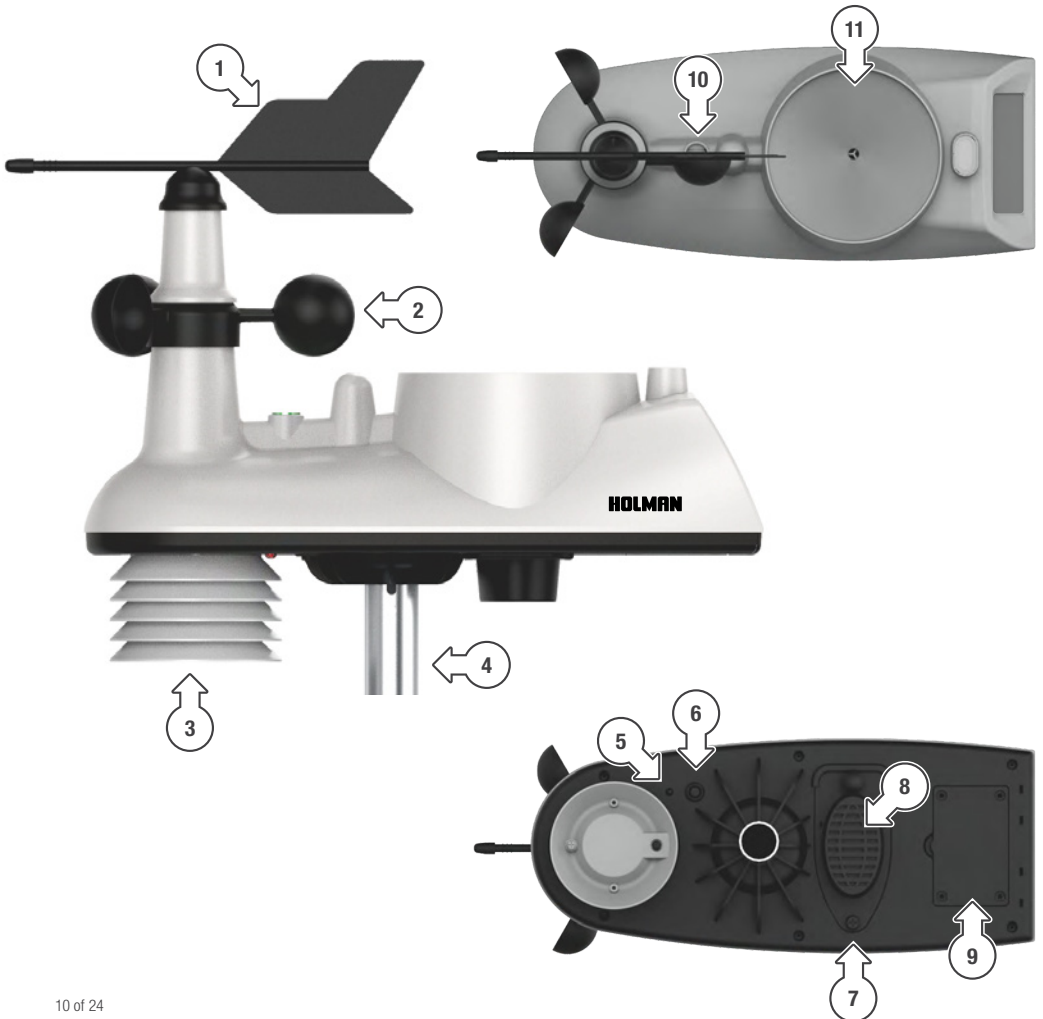

# Installation and Setup

## Setup Summary

---

- i** The following summary outlines the key setup steps for your **Zephyr Wi-Fi Weather Station**
- i** Refer to the following sections in this manual for more details on each setup step

- STEP i:** Set up the **Outdoor Sensor** by installing batteries
- STEP ii:** Set up your **Display Panel** and connect to your **Outdoor Sensor**
- STEP iii:** Connect your **Weather Station** to **Holman Home**
- STEP iv:** Mount your **Outdoor Sensor**
- STEP v:** Manual Time Setup (if not connecting to Wi-Fi) and Configure Unit Settings (also available on the app)

## STEP i: Outdoor Sensor Setup

---

- i** Use 3 x AA size, 1.5V Alkaline batteries (not included)

### Installing the batteries

1. Unscrew the battery cover (a) and insert **AA** batteries with the correct **+** and **-** polarity (e)



2. Observe the red LED light near the Hygro-Thermo sensor (f)

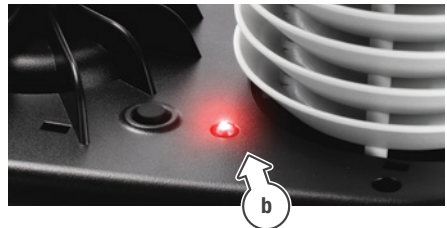

- i** This will flash every minute when transmitting RF signal to the **Display Panel**
3. Close the battery cover and replace the screws
- i** Batteries will require replacing periodically, low battery level is indicated on the **Display Panel** and app

# Installation and Setup (continued)

## STEP ii: Display Panel Setup and Connection

1. Open the battery cover located at the back of the **Display Panel** and insert **AAA** batteries (a) at the correct **+** and **-** polarity



- i** These batteries protect data in the case of a power outage
- i** The LCD on the **Display Panel** will activate and then return blank—press **SNOOZE/LIGHT** to reactivate

2. The **RF CONNECTION INDICATOR**  will flash for 3 minutes once battery power is established to enable connection to your outdoor sensor

- i** Ensure the **Outdoor Sensor** is powered within this time frame for easy connection
3. Connect the **Display Panel** to mains power using the supplied 5.0V, 1.2A adaptor
- i** The LCD on the **Display Panel** will activate
  - i** The **RF CONNECTION INDICATOR**  will be stable when RF connection has succeeded
  - i** Once RF connection is successful, outdoor temperature and humidity readings should be available
  - i** In case of connection failure, hold **SEARCH** at the top of the **Display Panel** for 5 seconds to try again

**⚠** When the batteries are replaced without AC power, the **Display Panel** will lose all weather data and settings, and will need to be resynchronised to the **Outdoor Sensor**

## STEP iii: Connecting to Holman Home

### Installing Holman Home

1. Download **Holman Home** to your mobile device via the **App Store** or **Google Play**

- ⚠** All app processes may change with software and OS updates on your device
- i** Visit our website for up-to-date details [www.holmanindustries.com.au/holman-home/](http://www.holmanindustries.com.au/holman-home/)

2. Open **Holman Home** on your mobile device
3. You may be prompted to allow notifications—the app can still function if you choose to opt out
4. Tap **SIGN UP**
5. Read our User Agreement and Privacy Policy and tap **AGREE** if you wish to proceed
6. Follow the prompts to register a **Holman Home** account with your email address

**⚠** Ensure your country details are correct at this stage

**⚠** You may be prompted to allow access your location. This is required for your weather station to work correctly

- i** We recommend having Bluetooth® active on your device before proceeding



For more features, like **SMART AUTOMATIONS**, check out [www.holmanindustries.com.au/WS5092W](http://www.holmanindustries.com.au/WS5092W) or scan this QR code!

# Installation and Setup (continued)

## STEP iii: Connecting to Holman Home (continued)

### Adding your Weather Station to Holman Home

1. Access the **HOME** screen for **Holman Home** as shown
2. Ensure the Wi-Fi indicator LED on the **Display Panel** (bottom right) is flashing red quickly
- ❗ If this LED is not flashing, press and hold **WIFI** on the top of the **Display Panel** until the front LED starts flashing red quickly
3. Tap **+** (a) or **ADD DEVICE** (b)
4. Follow the prompts within **Holman Home** to work through the Wi-Fi connection setup

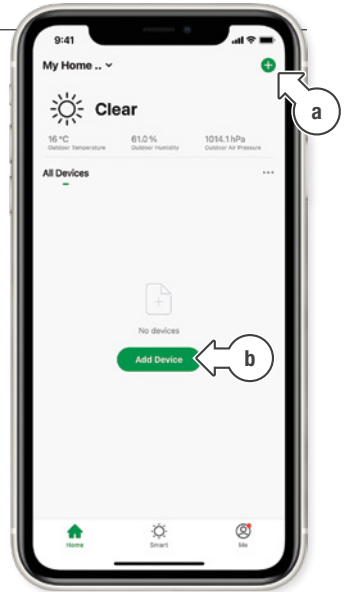

### Accessing Weather Data

1. Once linked to **Holman Home**, you can tap the **Zephyr** icon (c) on the **HOME** screen
2. Tap to open the **TODAY** screen for your Zephyr Weather station



3. This screen displays the following information:
  - d. Your **Weather Station** name, which can be changed by tapping ⚙️
  - e. Your **Weather Station** location
  - f. Live sensor data from your **Outdoor Sensor** and **Display Panel**
  - g. Additional weather data

❗ You may need to scroll down to access the additional weather information

4. For additional weather controls, use the navigation menu at the bottom to access:
  - h. **TODAY** screen for your Zephyr Weather Station
  - i. **ALARMS** for time alarms
  - j. **ALERTS** for temperature based alerts
  - k. **HISTORY** for historical weather data based on your sensor readings
  - l. **UNITS** to set measurement units for your weather data readings

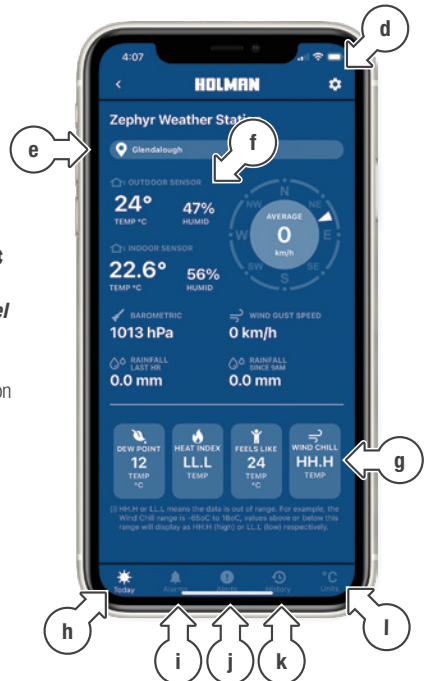

# Installation and Setup (continued)

## STEP iii: Connecting to Holman Home (continued)

### Setting Time Alarms

1. From the **TODAY** screen, tap **ALARMS** (i) in the bottom navigation bar

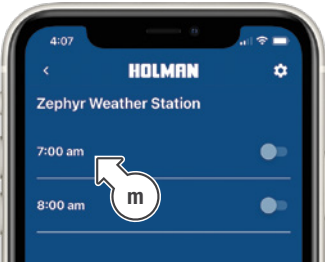

2. Tap one of the existing alarms (m) to access their settings
3. Toggle the alarm time as desired (n) and tap **SAVE** (o) to confirm



- i** Active alarms are indicated with **1** and/or **2** next to the time on the **Display Panel**
- i** Alarms will sound from the **Display Panel** for 2 minutes unless a button is pressed
- i** When an alarm sounds, press **SNOOZE/LIGHT** to snooze the alarm for 5 minutes
- i** Snooze can be disabled by pressing any other button on the **Display Panel**

### Setting Weather Alerts

1. From the **TODAY** screen, tap **ALERTS** (j) in the bottom navigation bar



2. Tap **INDOOR** (p) or **OUTDOOR** (q) as desired to set the alert conditions
- i** This will open alert settings to set the maximum and minimum temperature alerts

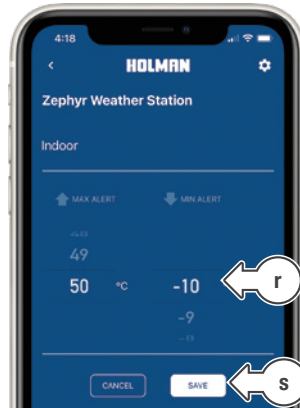

3. Once you have set the desired alert settings (r), tap **SAVE** (s) to confirm
- i** When a maximum or minimum temperature has been reached, the **Display Panel** will sound 5 beeps every minute until the temperature either drops or rises back within the range of the alert settings.
- i** The **Display Panel** will flash **▲** or **▼** against the relevant temperature reading

# Installation and Setup (continued)

## STEP iv: Mounting the Outdoor Sensor

---

1. For accurate readings, the metal pole should be securely mounted on a horizontal surface, at least 1.5 m above ground in an open area
  2. To ensure your **Outdoor Sensor** points in the correct direction, use a compass to establish North
  3. Hold the direction vane in line with the solar panel as shown (c) and wait for one minute
  4. Review **Holman Home** or the **Display Panel** and the wind direction should report as North
- i** If the vane does not report exactly North, adjust the **Outdoor Sensor** angle accordingly
  - 5. Ensure the **BALANCE SPIRIT LEVEL** (a) is centred before finalising mounting
  - i** Avoid trees and other obstacles where rainfall, wind speed or sunlight may be affected
  - i** Try to install as close as possible to your indoor **Display Panel**
  - i** Concrete walls and floors, and electronic devices can reduce transmission distance between the **Outdoor Sensor** and the **Display Panel**

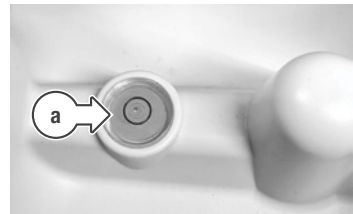
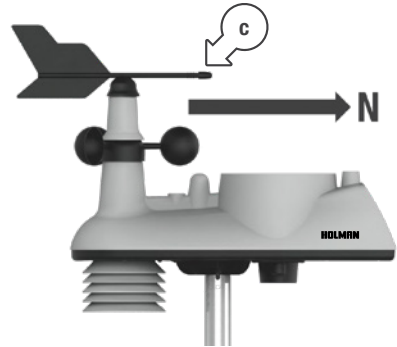

# Installation and Setup (continued)

## STEP v: Manual Time Setup (if not connecting to Wi-Fi) and Configure Unit Settings (also available on the app)

---

- i** Your **Display Panel** is in **Time Display** mode by default
- i** Once your **Display Panel** is connected to **Holman Home**, settings labelled with **⌚** below will be overridden by synchronised internet data—skip adjusting these settings if you intend to connect to **Holman Home**
- i** Your **Display Panel** should time sync every hour and display the correct date/time
- i** Your **Display Panel** will revert back to **Time Display** if no keys are pressed for 20 seconds

1. Press and hold **MODE** for three seconds to enter **Setup Mode**
2. The 12/24 hour indicator will flash; use **+** and **-** to select between 12 hour or 24 hour time, and **MODE** to confirm
3. **DM/MD** will flash in the **DATE** section; use **+** and **-** to toggle between **MD** (month/day) or **DM** (day/month) and press **MODE** to confirm
4. The **YEAR** will flash; use **+** and **-** to adjust, press **MODE** to confirm
5. The **MONTH** will flash; use **+** and **-** to adjust, press **MODE** to confirm
6. The **DATE** will flash; use **+** and **-** to adjust, press **MODE** to confirm
7. The hour will flash in the **TIME** section; use **+** and **-** to adjust, press **MODE** to confirm
8. The minutes will flash in the **TIME** section; use **+** and **-** to adjust, press **MODE** to confirm
9. The **TEMPERATURE UNIT (°C/°F)** will flash; use **+** and **-** to adjust, press **MODE** to confirm
10. The **BAROMETER UNIT (hPa/inHg)** will flash; use **+** and **-** to adjust, press **MODE** to confirm
11. The **WIND UNIT (kmh/mpH)** will flash; use **+** and **-** to adjust, press **MODE** to confirm
12. The **RAIN UNIT (mm/in)** will flash; use **+** and **-** to adjust, press **MODE** to confirm

### Mounting the Display Panel (Optional)

---

- i** The **Display Panel** can be placed onto any flat surface, wall mounted at the desired location using mounting hole
- i** Ensure the **Display Panel** has easy to access AC power when installing



# Operation and Settings

## Temperature Units °C/°F Selection

---

- When in **Setup Mode**—[refer to page 16: step 9](#)

## Daily Max/Min

---

- When in **Time Display**, your **Display Panel** will show live indoor/outdoor temperature and humidity data
- Press **+** to display the current day maximum temperature and humidity
  - Hold **+** for more than three seconds to clear the maximum daily records
- Press **+** again to display the current day minimum temperature and humidity
  - Hold **+** for more than three seconds to clear the minimum daily records

## Temperature and Humidity Trends

---

- Current temperature and humidity trends are indicated by arrows next to the relevant readings in the **INDOOR** and **OUTDOOR** sections on the **Display Panel**, as follows:

-  Trending up
-  Stable
-  Trending down

## Air Pressure

---

- Air pressure can be displayed in **hPa** or **inHg** in the **BARO** section on the **Display Panel**
- When in **Setup Mode**—[refer to page 16: step 10](#)

## Wind Speed and Direction

---

- Wind speed and direction data is updated once every minute
- To change the wind speed units—[refer to page 16: step 11](#)

## Rainfall

---

- When in **Time Display**, press **—** to cycle through the available data readings: **TODAY** (as of 9 am), **YESTERDAY** (as of 9 am) and **TOTAL**
- If any reading exceeds the maximum of 999.9mm, the **RAIN** display will flash. This data must be deleted by manual selection or it will not update past these readings.
- Hold **—** for more than three seconds when displaying any of the above readings to reset the data as desired—this is recommended when the maximum rainfall is exceeded or when using **TOTAL** to measure rainfall across a custom period of time. Holding **—** will only delete the data readings for the volume selected, all other readings will remain unchanged
- To change the rainfall units—[refer to page 16: step 12](#)

# Operation and Settings (continued)

## Index

---

- i** When in **Time Display**, press **SEARCH** to cycle through the available weather indexes: **FEELS LIKE** in °C, **DEW POINT** in °C, **WIND CHILL** in °C, and **HEAT INDEX** in °C
- i** If **INDEX** temperatures read **HH.H** or **LL.L**, the current reading is outside of the allowable **INDEX** range

## Backlight

---

- i** When in **Time Display**, press **SNOOZE/LIGHT** to toggle the display on/off
- i** When plugged in to AC power, the display will be on by default
- i** When relying solely on battery power, the display will be off by default

## Baro History Graph

---

- i** Graph data can take up to 72 hours to be accurate after initial setup
- i** **0 Hr** is the current baro reading which constantly updates every 15 minutes
- i** For example, if the time is 11:25 am, the reading at **0 Hr** is from 11:15 am.
- i** **-3 Hr** is the baro reading from 3 hours earlier, **-6 Hr** is from 6 hours earlier, and so on
- i** For example, if the current time is 12.XXpm, **-3 Hr** and **-6 Hr** readings will be for 9:00 am and 6:00 am respectively

## Moon Phase

---

- i** The **MOON PHASE** will be indicated as follows:

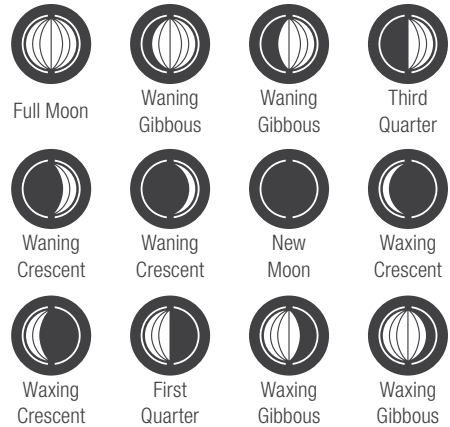

# Operation and Settings (continued)

## Adjusting the Barometric Pressure Reading

---

- i** The barometric pressure has been configured to the average altitude in Australia



### *To adjust the Barometric Pressure:*

- Hold **SNOOZE/LIGHT** for three seconds when in **Time Display**
  - The current air pressure offset will flash; use **+** and **-** to adjust accordingly
  - i** Each multiple of 10 will change the barometric pressure reading by approximately 1 hPa
  - When the desired offset is showing, press **SNOOZE/LIGHT** to confirm
  - The **FORECAST** icon for the selected rating will now flash; use **+** or **-** to cycle through the five forecast options: Sunny, Partly Cloudy, Cloudy, Rain, Storm
  - When the desired **FORECAST** icon is showing, press **SNOOZE/LIGHT** to confirm
- i** Your **Display Panel** will now be in back in the default **Time Display** mode



# Maintenance

## Low Batteries

### Indoor Display Panel:

- i** The batteries in your **Display Panel** protect the settings and data in the case of a power outage
- i** Be sure to use quality non-rechargeable alkaline batteries
- i** The **Display Panel** will highlight its own low battery with  in the **INDOOR** section of the display
- i** **Holman Home** will indicate the **Display Panel** battery status with the following:
  -  Low battery

### Outdoor Sensor:

- i** The **Display Panel** will highlight the status of the **Outdoor Sensor** batteries with  in the **OUTDOOR** section of the display
- i** **Holman Home** will indicate the **Outdoor Sensor** battery status with the following:
  -  Low battery
- i** If this battery is indicated as low, it will need to have new batteries installed
- i** Follow the [Outdoor Sensor Setup](#) instructions on [page 11](#) to change the batteries
- i** You may also need to follow the [Display Panel Setup and Connection](#) instructions on [page 12](#) to re-establish a connection between your Display Panel and Outdoor Sensor after the batteries have been replaced

## Outdoor Sensor Checks

- i** We highly recommend checking the rainfall and hygro-thermo sensors twice a year; once after winter and once after summer

## Rainfall Sensor Access

- To access the rainfall sensor, first locate the access screw (a) on the underside of your **Outdoor Sensor**
- Remove the rainfall sensor (b) and set aside
- Clear any debris from inside the **Outdoor Sensor** and also within the rainfall sensor
- Replace the rainfall sensor and access screw before re-mounting your **Outdoor Sensor**

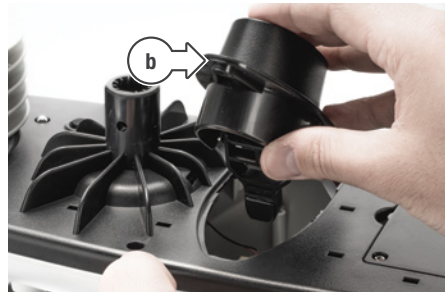

# Maintenance (continued)

## Hygro-Thermo Sensor Access







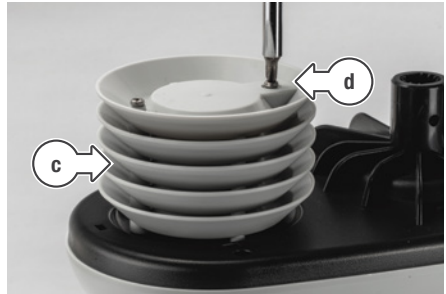



1. To access the hygro-thermo sensor, locate the Stevenson house (c) underneath your **Outdoor Sensor**
2. Unscrew the Stevenson house using a screwdriver (d)
3. Remove the Stevenson house (e) from the **Outdoor Sensor** and set aside
4. Clear any debris from around the hygro-thermo sensor (f) and between the Stevenson house layers

**⚠ Do not use liquid to clean this—a soft brush, dry cloth or canned air would be suitable**

5. Replace the Stevenson house and screws before re-mounting your **Outdoor Sensor**



# Troubleshooting

Question	Answer
Why is my <b>Display Panel</b> blank?	<ul style="list-style-type: none"> <li><input checked="" type="checkbox"/> Press <b>SNOOZE/LIGHT</b> on the <b>Display Panel</b> to activate</li> <li><input checked="" type="checkbox"/> Double check AC power is still connected to the <b>Display Panel</b></li> <li><input checked="" type="checkbox"/> It isn't possible to run the activated screen for very long from batteries alone</li> </ul>
Why is data from the <b>Outdoor Sensor</b> blank on my <b>Display Panel</b> ?	<ul style="list-style-type: none"> <li><input checked="" type="checkbox"/> Check for the <b>RF CONNECTION INDICATOR</b> —if this is missing it means the connection to the <b>Outdoor Sensor</b> is broken</li> <li><input checked="" type="checkbox"/> Press <b>SEARCH</b> on the top of the <b>Display Panel</b> for 5 seconds to re-establish the connection</li> </ul>
Why don't my <b>Outdoor Sensor</b> readings seem accurate?	<ul style="list-style-type: none"> <li><input checked="" type="checkbox"/> Placement and levelling of your <b>Outdoor Sensor</b> is very important—if it is unbalanced or obstructed, weather readings will not be correct</li> </ul>
Why are some temperature readings showing as <b>HH.H</b> or <b>LL.L</b> ?	<ul style="list-style-type: none"> <li><input checked="" type="checkbox"/> Weather Index Modes such as Feels Like (-65–50°C) / Wind Chill (-65–18°C) / Heat Index (26–50°C) / Dew Point (-20–60°C) have limited ranges</li> <li><input checked="" type="checkbox"/> If the temperatures fall outside the range listed above, they will report as <b>LL.L</b> (low) or <b>HH.H</b> (high)</li> </ul>
Why is <b>Holman Home</b> listing my location as a foreign city?	<ul style="list-style-type: none"> <li><input checked="" type="checkbox"/> Check your mobile device settings to ensure location access has been granted to Holman Home</li> <li><input checked="" type="checkbox"/> This is required for your weather station to work correctly</li> </ul>
Why does my barometric pressure seem inaccurate?	<ul style="list-style-type: none"> <li><input checked="" type="checkbox"/> As your barometric pressure is dependent on your altitude, you may need to adjust your Barometric Pressure Offset</li> <li><input checked="" type="checkbox"/> Refer to <a href="#">Adjusting the Barometric Pressure Reading</a> on <a href="#">page 19</a> for more information</li> </ul>
Why are <b>MONTH</b> and <b>WEEK</b> graphs blank in <b>Holman Home</b> ?	<ul style="list-style-type: none"> <li><input checked="" type="checkbox"/> <b>MONTH</b> and <b>WEEK</b> graphs in <b>Holman Home</b> display average data over the given time period, with the exception of <b>RAINFALL</b>, which displays the total for each day</li> <li><input checked="" type="checkbox"/> <b>MONTH</b> and <b>WEEK</b> data in graphs does not include the current day</li> <li><input checked="" type="checkbox"/> <b>MONTH</b> and <b>WEEK</b> graphs require at least 2 days to be able to plot data into a graph—at the start of each <b>MONTH</b> or <b>WEEK</b>, no data will be shown until data has been logged for the first 2 days</li> <li><input checked="" type="checkbox"/> This means no data will be shown until the 3rd of each <b>MONTH</b>, or until Wednesday each <b>WEEK</b></li> </ul>
Why is data from the <b>Outdoor Sensor</b> blank on my display panel?	<ul style="list-style-type: none"> <li><input checked="" type="checkbox"/> Press <b>SEARCH</b> on the top of the <b>Display Panel</b> to reconnect the <b>Outdoor Sensor</b></li> <li><input checked="" type="checkbox"/> If <b>SEARCH</b> doesn't reconnect the <b>Outdoor Sensor</b>, press <b>SYNC</b> on the <b>Outdoor Sensor</b> followed by <b>SEARCH</b> on the <b>Display Panel</b>, to have both units searching and broadcasting</li> </ul>
How can I turn off time <b>ALARMS</b> and weather <b>ALERTS</b> ?	<ul style="list-style-type: none"> <li><input checked="" type="checkbox"/> <b>ALARMS</b> and <b>ALERTS</b> can be turned on and off from the <b>Display Panel</b></li> <li><input checked="" type="checkbox"/> Remove <b>ALARMS</b>: press <b>MODE</b> on the top of the <b>Display Panel</b> to access the  1 and  2 time <b>ALARMS</b></li> <li><input checked="" type="checkbox"/> Press  on top of <b>Display Panel</b> to remove <b>ALARMS</b> (the  icon will disappear)</li> <li><input checked="" type="checkbox"/> The <b>Holman Home</b> alarms will also be disabled</li> <li><input checked="" type="checkbox"/> Remove <b>ALERTS</b>: press <b>MODE</b> on the top of the <b>Display Panel</b> to cycle through <b>ALARMS</b> and access the max.  and min.  outdoor weather <b>ALERTS</b></li> <li><input checked="" type="checkbox"/> Press  on top of display panel to remove outdoor weather <b>ALERTS</b> (the  or  icon will disappear)</li> <li><input checked="" type="checkbox"/> The <b>Holman Home</b> alerts will also be disabled</li> </ul>

# Warranty

## 3 Year Replacement Guarantee

---

Holman offers a 3 year replacement guarantee with this product.

In Australia our goods come with guarantees that cannot be excluded under the Australian Consumer Law. You are entitled to a replacement or refund for a major failure and compensation for any other reasonably foreseeable loss or damage. You are also entitled to have the goods repaired or replaced if the goods fail to be of acceptable quality and the failure does not amount to a major failure.

As well as your statutory rights referred to above and any other rights and remedies you have under any other laws relating to your Holman product, we also provide you with a Holman guarantee.

Holman guarantees this product against defects caused by faulty workmanship and materials for 3 years domestic use from the date of purchase. During this guarantee period Holman will replace any defective product. Packaging and instructions may not be replaced unless faulty.

In the event of a product being replaced during the guarantee period, the guarantee on the replacement product will expire 3 years from the purchase date of the original product, not 3 years from the date of replacement.

To the extent permitted by law, this Holman Replacement Guarantee excludes liability for consequential loss or any other loss or damage caused to property of persons arising from any cause whatsoever. It also excludes defects caused by the product not being used in accordance with instructions, accidental damage, misuse, or being tampered with by unauthorised persons, excludes normal wear and tear and does not cover the cost of claiming under the warranty or transporting the goods to and from the place of purchase.

Should you suspect your product may be defective and need some clarification or advice please contact us directly:

**1300 716 188**

[support@holmanindustries.com.au](mailto:support@holmanindustries.com.au)

**11 Walters Drive, Osborne Park 6017 WA**

If you are certain your product is defective and is covered by the terms of this warranty, you will need to present your defective product and your purchase receipt as proof of purchase to the place you purchased it from, where the retailer will replace the product for you on our behalf.



**Thanks for being a  
#SMARTGARDENER**



We really appreciate having you as a customer, and would like to say thank you for choosing us.

We recommend registering your new product on our website. This will ensure we have a copy of your purchase and activate an extended warranty. Keep up to date to with relevant product information and special offers available through our newsletter.



[www.holmanindustries.com.au/product-registration/](http://www.holmanindustries.com.au/product-registration/)

Thanks again for choosing Holman

**HOLMAN**

For the #SMARTGARDENER   

Copyright © 2023 Holman Industries